

VASF 1.80/1
VASF 1.80/2

Ersatzteilliste
Spare parts list
Liste de pièces de rechange
Listino pezzi di ricambio
Lista de piezas de recambio
Lista de peças sobresselentes
Reserveonderdelenlijst
Reservedelsliste
Reservdelslista

Reservedelsliste
Varaosaluettelo
Wykaz części zamiennych
Seznam náhradních dílů
Tartalékalkatrész lista
Κατάλογος ανταλλακτικών
Yedek parça listesi
Перечень запасных частей
备用零件目录
スペアパーツリスト

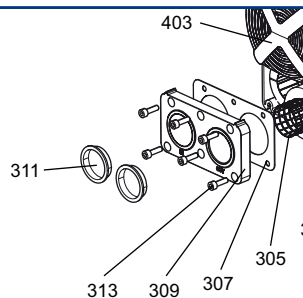

SERVICE

BECKER
D-42279 Wuppertal
www.becker-international.com

year XXXX
No (-) XXXX

type VASF 1.80/1-XX

frequency	XXXX	Hz
speed	XXXX	min ⁻¹
power required	XXXX	kW
inlet capacity	XXXX	m ³ /h
pressure +	XXXX	mbar
vacuum -	XXXX	mbar

Made in Germany

Index
Variante

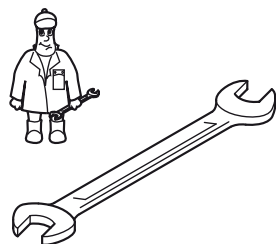

Wartung
Maintenance
Entretien
Manutenzione
Mantenimiento



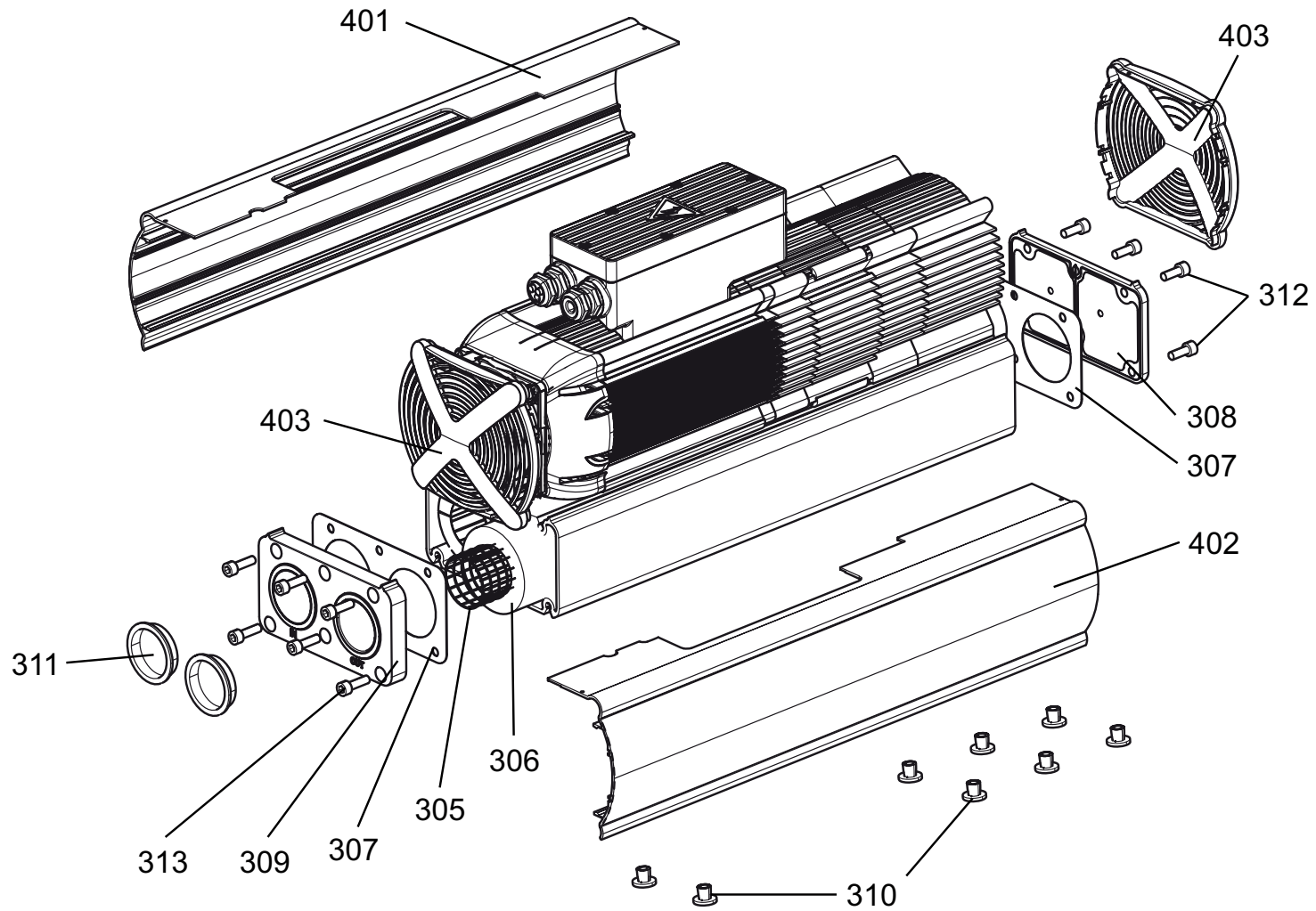

VASF 1.80/1
VASF 1.80/2

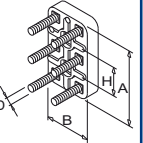
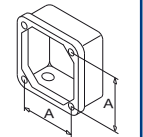
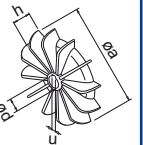
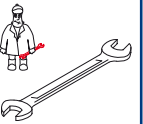

SERVICE ?



INDEX	Pos.	Bestell Nr.	Beschreibung	
VASF 1.80/1 VASF 1.80/2	305	907601 40000	SIEBROHR	
	306	907705 50000	DÄMPFERMATTE	
	307	907502 42700	FLACHDICHTUNG	
	308	005600 42700	DECKEL	
	309	007800 42700	GEWINDEFLANSCH	
	310	912801 00000	STOPFEN	
	311	912837 00000	PLASTIKSTOPFEN	
	313	946502 00000	INNENSECHSKANTSCHRAUBE, DIN7500 M6X20	
	401	006800 42700	GERÄTEHAUBE	
	402	006801 42700	GERÄTEHAUBE	
	403	002500 42700	ABDECKHAUBE	

INDEX	Pos.	Ident No.	Description	
VASF 1.80/1 VASF 1.80/2	305	907601 40000	STRAINER TUBE	
	306	907705 50000	SILENCER SPONGE	
	307	907502 42700	GASKET	
	308	005600 42700	COVER	
	309	007800 42700	CONNECTING FLANGE	
	310	912801 00000	PLUG	
	311	912837 00000	CUP NUT	
	313	946502 00000	SOCKET HEAD SCREW, DIN7500 M6X20	
	401	006800 42700	PROTECTING HOOD	
	402	006801 42700	PROTECTING HOOD	
	403	002500 42700	COVERING CAP	

INDICE	Pos.	No. identifikation	Designation	
VASF 1.80/1 VASF 1.80/2	305	907601 40000	GRILLE POUR SILENCIEUX	
	306	907705 50000	MOUSSE POUR SILENCIEUX	
	307	907502 42700	JOINT	
	308	005600 42700	COUVERCLE	
	309	007800 42700	BRIDE DE RACCORDEMENT	
	310	912801 00000	BOUCHON	
	311	912837 00000	ECROU BORGNE	
	313	946502 00000	VIS HEXAGONALE INTERNE, DIN7500 M6X20	
	401	006800 42700	CARTER PROTECTEUR	
	402	006801 42700	CARTER PROTECTEUR	
	403	002500 42700	CAPOT DE PROTECTION	

INDICE	Pos.	No. identificazione	Designazione	
VASF 1.80/1 VASF 1.80/2	305	907601 40000	GRIGLIA PER SILENZIATORE	
	306	907705 50000	MATERIALE PER SILENZIATORE	
	307	907502 42700	GUARNIZIONE	
	308	005600 42700	COPERCHIO	
	309	007800 42700	FLANGIA DI RACCORDO	
	310	912801 00000	TAPPO DI CHIUSURA	
	311	912837 00000	CAPRIDADO IN GOMMA	
	313	946502 00000	VITE ESAGONALE INTERNA, DIN7500 M6X20	
	401	006800 42700	CARTER DI PROTEZIONE	
	402	006801 42700	CARTER DI PROTEZIONE	
	403	002500 42700	COPERCHIO	

INDICE	Pos.	No. de pedido	Descripción	
VASF 1.80/1 VASF 1.80/2	305	907601 40000	TUBO DE CRIBA	
	306	907705 50000	AMORTIGUADOR	
	307	907502 42700	JUNTA	
	308	005600 42700	TAPA DE CIERRE	
	309	007800 42700	BRIDA DE EMPALME	
	310	912801 00000	TAPÓN DE DESGASTE	
	311	912837 00000	TAPÓN DE PLÁSTICO	
	313	946502 00000	TORNILLO HEXAGONAL INTERIOR, DIN7500 M6X20	
	401	006800 42700	CAPERUZA DE APARATO	
	402	006801 42700	CAPERUZA DE APARATO	
	403	002500 42700	TAPA	