

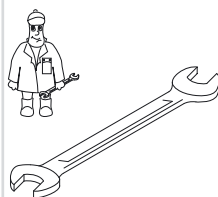

Gebr. Becker GmbH
Hölker Feld 29-31
D-42279 Wuppertal

Wartung
Maintenance
Entretien
Manutenzione
Mantenimiento



| | Pos. | Menge Quantity Quantité Quantità Cantidad | Bestell-Nr. Ident No. No. Identification No. Identificazione No. de pedido | Bezeichnung Description Designation Designazione Descripción |
|-----------------|------|---|--|---|
| SV 8.190 | 125 | 1* | 909568 00000 | Filterpatrone, Filter cartridge, Cartouche Filtrante, Cartuccia filtro, Cartucho de filtro |

* erforderlich / necessary / nécessaire / necessaria / necesaria (F / DSF / VSF)



Ersatzteilliste
Spare parts list
Liste de pièces de rechange
Listino pezzi di ricambio
Lista de piezas de recambio
Lista de peças sobresselentes
Reserveonderdelenlijst
Reservedelsliste
Reservdelslista

Reservedelsliste
Varaosaluettelo
Wykaz części zamiennych
Seznam náhradních dílů
Tartalékalkatrész lista
Κατάλογος ανταλλακτικών
Перечень запасных частей
备用零件目录
スペアパーツリスト

SV 8.190



28000041100 11/2009

SERVICE

BECKER
D-42279 Wuppertal
www.becker-international.com

CE

year XXXX

No. XXXXXXXX

type **SV 8.190-XX** ← Option

frequency XXXX Hz

speed XXXX min⁻¹

power required XXXX kW

inlet capacity XXXX m³/h

pressure + XXXX mbar

vacuum - XXXX mbar

Made in Germany

(D) Service:

Tel: +49 (0)202 697-171

Fax: +49 (0)202 64 44 74

E-Mail: info@becker-international.com

www.becker-international.com

| Index | Pos. | Bestell Nr. | Beschreibung  |
|-----------------|--------------|---------------------------|---|
| SV 8.190 | 8 | 570400 19600 | UMBAUSATZ /1⇒/2 (POS: 67, 119, 181, 183, 184, 185, 218) |
| | 12 | 515101 19600 | FUSS - SEITLICH, KOMPLETT |
| | 14 | 515103 41100 | GERÄTEFUSS, KOMPLETT |
| | 27 | 000100 41100 | GEHÄUSE |
| | 29 | 911310 00000 | DICHTUNGSSCHLAUCH |
| | 30 | 951704 00000 | FEDERSCHEIBE |
| | 31 | 945314 00000 | INNENSECHSKANTSCHRAUBE |
| | 48 | 947736 00000 | PASSFEDER |
| | 49 | 000600 41100 | LAUFRAD |
| | 50 | 013900 41100 | DISTANZBUCHSE |
| | 51 | 001100 41100 | LAGERDECKEL |
| | 53 | 906624 00000 | LAGER |
| | 54 | 016800 30200 | SPANNSCHEIBE |
| | 55 | 901805 00000 | WELLENENDSCHRAUBE |
| | 59 | 911447 00000 | DISTANZSCHEIBE |
| | 60 | 911403 00000 | ZWISCHENLEGRING |
| | 63 | 000200 41100 | GEHÄUSEDECKEL |
| | 65 | 945311 00000 | INNENSECHSKANTSCHRAUBE |
| | 67 | 951703 00000 | FEDERSCHEIBE |
| | 68 | 945321 00000 | INNENSECHSKANTSCHRAUBE |
| | 101 | 007400 19600 | SCHALLDÄMPFERGEHÄUSE |
| | 102 | 907600 60000 | SIEBROHR |
| | 103 | 907701 70000 | DÄMPFER |
| | 104 | 907500 19600 | DICHTUNG |
| | 105 | 007800 19600 | GEWINDEFLENSCH |
| | 107 | 949451 00000 | UNTERLEGSCHNEIBE |
| | 108 | 903804 01000 | ZUGANKERSCHRAUBE |
| | 109 | 903805 01000 | ZUGANKERSCHRAUBE |
| | 110 | 903803 01000 | ZUGANKERSCHRAUBE |
| | 111 | 945225 00000 | SECHSKANTSCHRAUBE |
| | 113 | 040100 19600 | FILTERGEHÄUSE |
| | 119 | 945371 00000 | INNENSECHSKANTSCHRAUBE |
| | 121 | 951007 00000 | STIFTSCHRAUBE |
| | 125 | 909568 00000 | FILTERPATRONE (1x) ¹⁾ |
| | 127 | 040200 19700 | FILTER DECKEL |
| | 131 | 921503 00000 | STERNGRIF |
| | 134 | 016600 19600 | ANSCHLUSS-STÜCK |
| | 137 | 040201 19700 | FILTERDECKEL |
| | 181 | 015500 19600 | REDUZIERSTÜCK |
| | 183 | 005602 19600 | DECKEL |
| 184 | 907502 19600 | DICHTUNG | |
| 185 | 005600 19600 | DECKEL | |
| 201 | 015100 19600 | FUSS | |
| 202 | 947504 00000 | UNTERLEGSCHNEIBE | |
| 203 | 945223 00000 | SECHSKANTSCHRAUBE | |
| 204 | 951906 00000 | KABELTÜLLE | |
| 205 | 015101 19600 | FUSS, SEITLICH | |
| 207 | 945328 00000 | INNENSECHSKANTSCHRAUBE | |
| 215 | 741315 00000 | GUMMIPUFFER | |
| 216 | 015101 79000 | GERÄTEFUSS | |
| 218 | 945320 00000 | INNENSECHSKANTSCHRAUBE | |
| 301 | 007401 19600 | SCHALLDÄMPFERGEHÄUSE | |
| 302 | 907600 70100 | SIEBROHR | |
| 303 | 907702 10000 | DÄMPFER | |
| 400.1 | 733700 99581 | VENTILEINSATZ, < 0,170BAR | |
| 400.2 | 733701 99581 | VENTILEINSATZ, < 0,285BAR | |
| 400.3 | 733702 99581 | VENTILEINSATZ, < 0,440BAR | |
| 400.4 | 733703 99581 | VENTILEINSATZ, < 0,500BAR | |

| Index | Pos. | Bestell Nr. | Beschreibung  |
|----------|------------------|--|---|
| Variante | /1-05 /2-05 | MIT KORROSIONSSCHUTZ ²⁾ | |
| | 181 185 | 570410 19600 015510 19600 005610 19600 | UMBAUSATZ /1⇒/2 - REDUZIERSTÜCK - DECKEL |
| | 27 49 63 | 570210 41100 000110 41100 000610 41100 | VERDICHTER / VAKUUMPUMPE - GEHÄUSE - LAUFRAD |
| | 101 102 | 570301 19600 007410 19600 907600 60100 | SCHALLDÄMPFER (2x) - SCHALLDÄMPFERGEHÄUSE - SIEBROHR |
| Variante | /1-401 /2-401 | MIT FREQUENZUMRICHTER ²⁾ | |
| | 49 413 415 | 570201 41100 000601 41100 796302 41115 503603 41100 | VERDICHTER / VAKUUMPUMPE - LAUFRAD FREQUENZUMRICHTER (4,0KW) ADAPTERPLATTE |
| Variante | /2-501 | SONDERAUSFÜHRUNG ²⁾ | |
| | 27 63 | 000102 41100 000202 41100 | GEHÄUSE GEHÄUSEDECKEL |
| Variante | /2-600 | SONDERAUSFÜHRUNG ²⁾ | |
| | 49 | 570201 41100 000601 41100 | VERDICHTER / VAKUUMPUMPE - LAUFRAD |

¹⁾ erforderliche Bestellmenge / Wartung (F / DSF / VSF)
²⁾ variantenabhängige Bauteile

Zeichnung - siehe Anhang 



| Index | Pos. | Ident No. | Description  |
|----------|--------------|------------------------|--|
| SV 8.190 | 8 | 570400 19600 | CONVERSION SET /1⇒ /2 (POS: 67, 119, 181, 183, 184, 185, 218) |
| | 12 | 515101 19600 | FOOT - LATERAL, COMPLETE |
| | 14 | 515103 41100 | FOOT, COMPLETE |
| | 27 | 000100 41100 | PUMP BODY |
| | 29 | 911310 00000 | SEAL |
| | 30 | 951704 00000 | SPRING DISC |
| | 31 | 945314 00000 | SOCKET HEAD SCREW |
| | 48 | 947736 00000 | KEY |
| | 49 | 000600 41100 | IMPELLER |
| | 50 | 013900 41100 | SPACER |
| | 51 | 001100 41100 | BEARING COVER |
| | 53 | 906624 00000 | BALL BEARING |
| | 54 | 016800 30200 | IDLER |
| | 55 | 901805 00000 | SHAFT END SCREW |
| | 59 | 911447 00000 | DISTANCE DISC |
| | 60 | 911403 00000 | RING |
| | 63 | 000200 41100 | HOUSING LID |
| | 65 | 945311 00000 | SOCKET HEAD SCREW |
| | 67 | 951703 00000 | LOCKING WASHER |
| | 68 | 945321 00000 | SOCKET HEAD SCREW |
| | 101 | 007400 19600 | SILENCER HOUSING |
| | 102 | 907600 60000 | STRAINER TUBE |
| | 103 | 907701 70000 | SILENCER SPONGE |
| | 104 | 907500 19600 | GASKET |
| | 105 | 007800 19600 | FLANGE |
| | 107 | 949451 00000 | WASHER |
| | 108 | 903804 01000 | SCREW |
| | 109 | 903805 01000 | SCREW |
| | 110 | 903803 01000 | ANCHORING SCREW |
| | 111 | 945225 00000 | HEX-HEAD SCREW |
| | 113 | 040100 19600 | FILTER HOUSING |
| | 119 | 945371 00000 | SOCKET HEAD SCREW |
| | 121 | 951007 00000 | STUD |
| | 125 | 909568 00000 | FILTER CARTRIDGE (1x) ¹⁾ |
| | 127 | 040200 19700 | FILTER COVER |
| | 131 | 921503 00000 | STAR GRIP |
| | 134 | 016600 19600 | CONNECTING PIECE |
| | 137 | 040201 19700 | FILTER COVER |
| | 181 | 015500 19600 | REDUCING PIECE |
| | 183 | 005602 19600 | COVER |
| 184 | 907502 19600 | GASKET | |
| 185 | 005600 19600 | COVER | |
| 201 | 015100 19600 | FOOT | |
| 202 | 947504 00000 | WASHER | |
| 203 | 945223 00000 | HEX-HEAD SCREW | |
| 204 | 951906 00000 | RUBBER BUSHING | |
| 205 | 015101 19600 | FOOT, LATERAL | |
| 207 | 945328 00000 | SOCKET HEAD SCREW | |
| 215 | 741315 00000 | RUBBER BUFFER | |
| 216 | 015101 79000 | FOOT | |
| 218 | 945320 00000 | SOCKET HEAD SCREW | |
| 301 | 007401 19600 | SILENCER HOUSING | |
| 302 | 907600 70100 | STRAINER TUBE | |
| 303 | 907702 10000 | SILENCER MATERIAL | |
| 400.1 | 733700 99581 | VALVE CORE, < 0,170BAR | |
| 400.2 | 733701 99581 | VALVE CORE, < 0,285BAR | |
| 400.3 | 733702 99581 | VALVE CORE, < 0,440BAR | |
| 400.4 | 733703 99581 | VALVE CORE, < 0,500BAR | |

| Index | Pos. | Ident No. | Description  |
|---------|------------------|---|---|
| Variant | /1-05 /2-05 | WITH CORROSION PROTECTION ²⁾ | |
| | 181 185 | 570410 19600 015510 19600 005610 19600 570210 41100 000110 41100 000610 41100 000210 41100 570301 19600 007410 19600 907600 60100 | CONVERSION KIT /1⇒ /2 - REDUCING PIECE - CAP BLOWER / VACUUM PUMP - PUMP BODY - IMPELLER - HOUSING LID SILENCER (2x) - SILENCER HOUSING - STRAINER TUBE |
| Variant | /1-401 /2-401 | WITH FREQUENCY INVERTER ²⁾ | |
| | 49 413 415 | 570201 41100 000601 41100 796302 41115 503603 41100 | BLOWER / VACUUM PUMP - IMPELLER FREQUENCY INVERTER (4,0KW) ADAPTER PLATE |
| Variant | /2-501 | SPECIAL DESIGN ²⁾ | |
| | 27 63 | 000102 41100 000202 41100 | PUMP BODY HOUSING LID |
| Variant | /2-600 | SPECIAL DESIGN ²⁾ | |
| | 49 | 570201 41100 000601 41100 | BLOWER / VACUUM PUMP - IMPELLER |



¹⁾ necessary order quantity / maintenance (F / DSF / VSF)
²⁾ variant-dependent components

Drawing - see appendix 

| Index | Pos. | No. Identification | Designation  |
|----------|--------------|---------------------------|--|
| SV 8.190 | 8 | 570400 19600 | ÉQUIPEMENT DE CONVERSION /1⇒ /2 (POS: 67, 119, 181, 183, 184, 185, 218) |
| | 12 | 515101 19600 | PIED - LATÉRAL, COMPLET |
| | 14 | 515103 41100 | PIED, COMPLET |
| | 27 | 000100 41100 | CORP DE POMPE |
| | 29 | 911310 00000 | JOINT |
| | 30 | 951704 00000 | DISQUE DE RESSORT |
| | 31 | 945314 00000 | VIS HEXAGONALE INTERNE |
| | 48 | 947736 00000 | CLAVETTE |
| | 49 | 000600 41100 | ROUE |
| | 50 | 013900 41100 | DOUILLE ETANCHEITE |
| | 51 | 001100 41100 | COUVERCLE DE ROULEMENTE |
| | 53 | 906624 00000 | ROULEMENT A BILLES |
| | 54 | 016800 30200 | POULIE DE TENSION |
| | 55 | 901805 00000 | VIS SIX-PANS |
| | 59 | 911447 00000 | DISQUE AJUSTAGE |
| | 60 | 911403 00000 | BAGUE |
| | 63 | 000200 41100 | COUVERCLE |
| | 65 | 945311 00000 | VIS HEXAGONALE INTERNE |
| | 67 | 951703 00000 | RONDELLE À RESSORT |
| | 68 | 945321 00000 | VIS HEXAGONALE INTERNE |
| | 101 | 007400 19600 | CORPS DE LA SILENCIEUX |
| | 102 | 907600 60000 | GRILLE POUR SILENCIEUX |
| | 103 | 907701 70000 | MOUSSE POUR SILENCIEUX |
| | 104 | 907500 19600 | JOINT |
| | 105 | 007800 19600 | BRIDE |
| | 107 | 949451 00000 | RONDELLE |
| | 108 | 903804 01000 | VIS |
| | 109 | 903805 01000 | VIS |
| | 110 | 903803 01000 | VIS |
| | 111 | 945225 00000 | VIS HEXAGONALE |
| | 113 | 040100 19600 | BOITE POUR FILTRE |
| | 119 | 945371 00000 | VIS HEXAGONALE INTERNE |
| | 121 | 951007 00000 | PRISONNIER |
| | 125 | 909568 00000 | CARTOUCHE FILTRANTE (1x) ¹⁾ |
| | 127 | 040200 19700 | COUVERCLE DU FILTRE |
| | 131 | 921503 00000 | POIGNEE-ETOILE |
| | 134 | 016600 19600 | PIECE RACCORD |
| | 137 | 040201 19700 | COUVERCLE DU FILTRE |
| | 181 | 015500 19600 | PIECE DE REDUCTION |
| | 183 | 005602 19600 | COUVERCLE |
| 184 | 907502 19600 | JOINT | |
| 185 | 005600 19600 | COUVERCLE | |
| 201 | 015100 19600 | PIED | |
| 202 | 947504 00000 | RONDELLE | |
| 203 | 945223 00000 | VIS HEXAGONALE | |
| 204 | 951906 00000 | PROTECTION EN CAOUTCHOUC | |
| 205 | 015101 19600 | PIED - LATERAL | |
| 207 | 945328 00000 | VIS HEXAGONALE INTERNE | |
| 215 | 741315 00000 | AMORTISSEUR EN CAOUTCHOUC | |
| 216 | 015101 79000 | PIED | |
| 218 | 945320 00000 | VIS HEXAGONALE INTERNE | |
| 301 | 007401 19600 | CARCASSE SILENCIEUX | |
| 302 | 907600 70100 | TUYAU-TAMIS | |
| 303 | 907702 10000 | MATERIAL POUR SILENCIEUX | |
| 400.1 | 733700 99581 | SOUPAPE, < 0,170BAR | |
| 400.2 | 733701 99581 | SOUPAPE, < 0,285BAR | |
| 400.3 | 733702 99581 | SOUPAPE, < 0,440BAR | |
| 400.4 | 733703 99581 | SOUPAPE, < 0,500BAR | |

| Index | Pos. | No. Identification | Designation  |
|--|--|---|---|
| Variante | /1-05 /2-05 | AVEC PROT. CONTRE LA CORROSION ²⁾ | |
| | 181 185 27 49 63 101 102 | 570410 19600 015510 19600 005610 19600 570210 41100 000110 41100 000610 41100 000210 41100 570301 19600 007410 19600 907600 60100 | KIT DE TRANSFORMATION /1⇒ /2 - PIECE DE REDUCTION - COUVERCLE SOUFFLANTE / POMPE A VIDE - CORP DE POMPE - ROUE - COUVERCLE DE CARTER SILENCIEUX (2x) - CARCASSE SILENCIEUX - GRILLE POUR SILENCIEUX |
| Variante | /1-401 /2-401 | AVEC CONVERTISSEUR DE FRÉQUENCE ²⁾ | |
| | 49 413 415 | 570201 41100 000601 41100 796302 41115 503603 41100 | SOUFFLANTE / POMPE A VIDE - ROUE CONVERTISSEUR DE FRÉQUENCE (4,0KW) PLATINE D'ADAPTION |
| Variante | /2-501 | FABRICATION SPÉCIALE ²⁾ | |
| | 27 63 | 000102 41100 000202 41100 | CORP DE POMPE COUVERCLE |
| Variante | /2-600 | FABRICATION SPÉCIALE ²⁾ | |
| | 49 | 570201 41100 000601 41100 | SOUFFLANTE / POMPE A VIDE - ROUE |
| ¹⁾ quantité nécessaire / entretien (F / DSF / VSF) ²⁾ composants variante-dependantes | | | |
| plan - voir annexe  | | | |

| Index | Pos. | No. Identificazione | Designazione  |
|-----------------|--------------|----------------------------|---|
| SV 8.190 | 8 | 570400 19600 | ATTREZZATURA PER LA TRASFORMAZIONE /1⇒/2 (POS: 67, 119, 181, 183, 184, 185, 218) |
| | 12 | 515101 19600 | PIEDE - LATERALE, COMPLETO |
| | 14 | 515103 41100 | PIEDE, COMPLETO |
| | 27 | 000100 41100 | CARCASSA |
| | 29 | 911310 00000 | GUARNIZIONE |
| | 30 | 951704 00000 | DISCO A MOLLA |
| | 31 | 945314 00000 | VITE ESAGONALE INTERNA |
| | 48 | 947736 00000 | CHIAVETTA |
| | 49 | 000600 41100 | GIRANTE |
| | 50 | 013900 41100 | BOCCOLA |
| | 51 | 001100 41100 | COPERCHIO CUSCINETTO |
| | 53 | 906624 00000 | CUSCINETTO A SFERA |
| | 54 | 016800 30200 | PULEGGIA DI TENSIONE |
| | 55 | 901805 00000 | VITE ESAGONALE |
| | 59 | 911447 00000 | DISCO GIUOCO |
| | 60 | 911403 00000 | ANELLO |
| | 63 | 000200 41100 | COPERCHIO |
| | 65 | 945311 00000 | VITE ESAGONALE INTERNA |
| | 67 | 951703 00000 | DISCO A MOLLA |
| | 68 | 945321 00000 | VITE ESAGONALE INTERNA |
| | 101 | 007400 19600 | CARCASSA SILENZIATORE |
| | 102 | 907600 60000 | TUBO-CRIVELLO |
| | 103 | 907701 70000 | MATERIALE PER SILENZIATORE |
| | 104 | 907500 19600 | GUARNIZIONE |
| | 105 | 007800 19600 | FLANGIA |
| | 107 | 949451 00000 | RONDELLA |
| | 108 | 903804 01000 | VITE |
| | 109 | 903805 01000 | VITE |
| | 110 | 903803 01000 | VITE |
| | 111 | 945225 00000 | VITE ESAGONALE |
| | 113 | 040100 19600 | CONTENITORE FILTRO A CARTUCCIA |
| | 119 | 945371 00000 | VITE ESAGONALE INTERNA |
| | 121 | 951007 00000 | L'ASTA A VITE |
| | 125 | 909568 00000 | CARTUCCIA FILTRO (1x) ¹⁾ |
| | 127 | 040200 19700 | COPERCHIO FILTRO |
| | 131 | 921503 00000 | MANOPOLA A CROCIERA |
| | 134 | 016600 19600 | PEZZI RACCORDI |
| | 137 | 040201 19700 | COPERCHIO FILTRO |
| | 181 | 015500 19600 | GIUNTO DI RIDUZIONE |
| | 183 | 005602 19600 | COPERCHIO |
| 184 | 907502 19600 | GUARNIZIONE | |
| 185 | 005600 19600 | COPERCHIO | |
| 201 | 015100 19600 | PIEDE | |
| 202 | 947504 00000 | RONDELLA | |
| 203 | 945223 00000 | VITE ESAGONALE | |
| 204 | 951906 00000 | PROTEZIONE IN GOMMA | |
| 205 | 015101 19600 | PIEDE - LATERALE | |
| 207 | 945328 00000 | VITE ESAGONALE INTERNA | |
| 215 | 741315 00000 | AMMORTIZZATORE IN GOMMA | |
| 216 | 015101 79000 | PIASTRA DI APPOGGIO | |
| 218 | 945320 00000 | VITE ESAGONALE INTERNA | |
| 301 | 007401 19600 | CARCASSA SILENZIATORE | |
| 302 | 907600 70100 | TUBO-CRIVELLO | |
| 303 | 907702 10000 | MATERIALE PER SILENZIATORE | |
| 400.1 | 733700 99581 | VALVOLA, < 0,170BAR | |
| 400.2 | 733701 99581 | VALVOLA, < 0,285BAR | |
| 400.3 | 733702 99581 | VALVOLA, < 0,440BAR | |
| 400.4 | 733703 99581 | VALVOLA, < 0,500BAR | |

| Index | Pos. | No. Identificazione | Designazione  |
|--|------------------|--|--|
| Variante | /1-05 /2-05 | CON PROTEZIONE ANTI-CORROSIONE ²⁾ | |
| | 181 185 | 570410 19600 015510 19600 005610 19600 | SET DI TRASFORMAZIONE /1⇒/2 - GIUNTO DI RIDUZIONE - COPERCHIO |
| | 27 49 63 | 570210 41100 000110 41100 000610 41100 | SOFFIANTE / POMPA A VUOTO - CARCASSA - GIRANTE |
| | 101 102 | 570301 19600 007410 19600 907600 60100 | SILENZIATORE (2x) - CARCASSA SILENZIATORE - TUBO-CRIVELLO |
| Variante | /1-401 /2-401 | CON CONVERTITORE DI FREQUENZA ²⁾ | |
| | 49 413 415 | 570201 41100 000601 41100 796302 41115 503603 41100 | SOFFIANTE / POMPA A VUOTO - GIRANTE CONVERTITORE DI FREQUENZA (4,0KW) ADATTATORE PIATTO |
| Variante | /2-501 | MODELLO SPECIALE ²⁾ | |
| | 27 63 | 000102 41100 000202 41100 | CARCASSA COPERCHIO DELLA CARCASSA |
| Variante | /2-600 | MODELLO SPECIALE ²⁾ | |
| | 49 | 570201 41100 000601 41100 | SOFFIANTE / POMPA A VUOTO - GIRANTE |
| ¹⁾ quantità di ordinazione necessari / manutenzione (F / DSF / VSF) ²⁾ componenti variante-dipendenti | | | |
| Disegno - vedere allegato  | | | |

| Index | Pos. | No. De pedido | Descripción |  |
|----------|--------------|------------------------------|--|--|
| SV 8.190 | 8 | 570400 19600 | EQUIPO PARA LA CONVERSIÓN /1⇒ /2 (POS: 67, 119, 181, 183, 184, 185, 218) | |
| | 12 | 515101 19600 | PIE - LATERAL, COMPLETO | |
| | 14 | 515103 41100 | PIE, COMPLETO | |
| | 27 | 000100 41100 | CARCASA | |
| | 29 | 911310 00000 | MANGUERA DE JUNTA | |
| | 30 | 951704 00000 | ARANDELA ELÁSTICA | |
| | 31 | 945314 00000 | TORNILLO HEXAGONAL INTERIOR | |
| | 48 | 947736 00000 | LENGÜETA DE AJUSTE | |
| | 49 | 000600 41100 | RUEDA CORREDERA | |
| | 50 | 013900 41100 | CASQUILLO DISTANCIADOR | |
| | 51 | 001100 41100 | TAPA DE COJINETE | |
| | 53 | 906624 00000 | COJINETE DE RODAMIENTO | |
| | 54 | 016800 30200 | POLEA TENSORA | |
| | 55 | 901805 00000 | TORNILLO DE CABEZA HEXAGONAL | |
| | 59 | 911447 00000 | ARANDELA DISTANCIADORA | |
| | 60 | 911403 00000 | ANILLO DE COLOCACIÓN INTERMEDIO | |
| | 63 | 000200 41100 | TAPA DE CARCASA | |
| | 65 | 945311 00000 | TORNILLO HEXAGONAL INTERIOR | |
| | 67 | 951703 00000 | ARANDELA ELÁSTICA | |
| | 68 | 945321 00000 | TORNILLO HEXAGONAL INTERIOR | |
| | 101 | 007400 19600 | CARCASA DE SILENCIADOR | |
| | 102 | 907600 60000 | TUBO DE CRIBA | |
| | 103 | 907701 70000 | AMORTIGUADOR | |
| | 104 | 907500 19600 | JUNTA | |
| | 105 | 007800 19600 | BRIDA ROSCADA | |
| | 107 | 949451 00000 | ARANDELA | |
| | 108 | 903804 01000 | TORNILLO TIRANTE | |
| | 109 | 903805 01000 | TORNILLO TIRANTE | |
| | 110 | 903803 01000 | TORNILLO TIRANTE | |
| | 111 | 945225 00000 | TORNILLO DE CABEZA HEXAGONAL | |
| | 113 | 040100 19600 | CARCASA DE FILTRO | |
| | 119 | 945371 00000 | TORNILLO HEXAGONAL INTERIOR | |
| | 121 | 951007 00000 | ESPÁRRAGO | |
| | 125 | 909568 00000 | CARTUCHO FILTRANTE (1x) ¹⁾ | |
| | 127 | 040200 19700 | FILTRO TAPA | |
| | 131 | 921503 00000 | EMPUÑADURA DE ESTRELLA | |
| | 134 | 016600 19600 | PIEZA DE EMPALME | |
| | 137 | 040201 19700 | TAPA DE FILTRO | |
| | 181 | 015500 19600 | PIEZA DE REDUCCIÓN | |
| | 183 | 005602 19600 | TAPA | |
| 184 | 907502 19600 | JUNTA | | |
| 185 | 005600 19600 | TAPA | | |
| 201 | 015100 19600 | PIE | | |
| 202 | 947504 00000 | ARANDELA | | |
| 203 | 945223 00000 | TORNILLO DE CABEZA HEXAGONAL | | |
| 204 | 951906 00000 | BOQUILLA DE CABLE | | |
| 205 | 015101 19600 | PIE - LATERAL | | |
| 207 | 945328 00000 | TORNILLO HEXAGONAL INTERIOR | | |
| 215 | 741315 00000 | AMORTIGUADOR DE GOMA | | |
| 216 | 015101 79000 | PIE DE APARATO | | |
| 218 | 945320 00000 | TORNILLO HEXAGONAL INTERIOR | | |
| 301 | 007401 19600 | CARCASA DE SILENCIADOR | | |
| 302 | 907600 70100 | TUBO DE CRIBA | | |
| 303 | 907702 10000 | AMORTIGUADOR PANTARIN | | |
| 400.1 | 733700 99581 | VÁLVULA, < 0,170BAR | | |
| 400.2 | 733701 99581 | VÁLVULA, < 0,285BAR | | |
| 400.3 | 733702 99581 | VÁLVULA, < 0,440BAR | | |
| 400.4 | 733703 99581 | VÁLVULA, < 0,500BAR | | |

| Index | Pos. | No. De pedido | Descripción |  |
|----------|------------------|--|--|--|
| Variante | /1-05 /2-05 | CON PROTECCIÓN CONTRA LA CORROSION ²⁾ | | |
| | 181 185 | 570410 19600 015510 19600 005610 19600 | EQUIPO PARA LA CONVERSIÓN /1⇒ /2 - PIEZA DE REDUCCIÓN - TAPA | |
| | 27 49 63 | 570210 41100 000110 41100 000610 41100 000210 41100 | SOPLANTES / BOMBA DE VACIO - CARCASA - RUEDA CORREDERA - TAPA DE CARCASA | |
| | 101 102 | 570301 19600 007410 19600 907600 60100 | SILENCIADOR (2x) - CARCASA DE SILENCIADOR - TUBO DE CRIBA | |
| Variante | /1-401 /2-401 | CON CONVERTIDOR DE FRECUENCIA ²⁾ | | |
| | 49 413 415 | 570201 41100 000601 41100 796302 41115 503603 41100 | SOPLANTES / BOMBA DE VACIO - RUEDA CORREDERA CONVERTIDOR DE FRECUENCIA (4,0KW) PLACA ADAPTADORA | |
| Variante | /2-501 | VERSIÓN ESPECIAL ²⁾ | | |
| | 27 63 | 000102 41100 000202 41100 | CARCASA TAPA DE CARCASA | |
| Variante | /2-600 | VERSIÓN ESPECIAL ²⁾ | | |
| | 49 | 570201 41100 000601 41100 | SOPLANTES / BOMBA DE VACIO - RUEDA CORREDERA | |

¹⁾ cantidad necesario / mantenimiento (F / DSF / VSF)
²⁾ componentes variante-dependientes

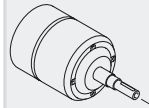

SERVICE ?

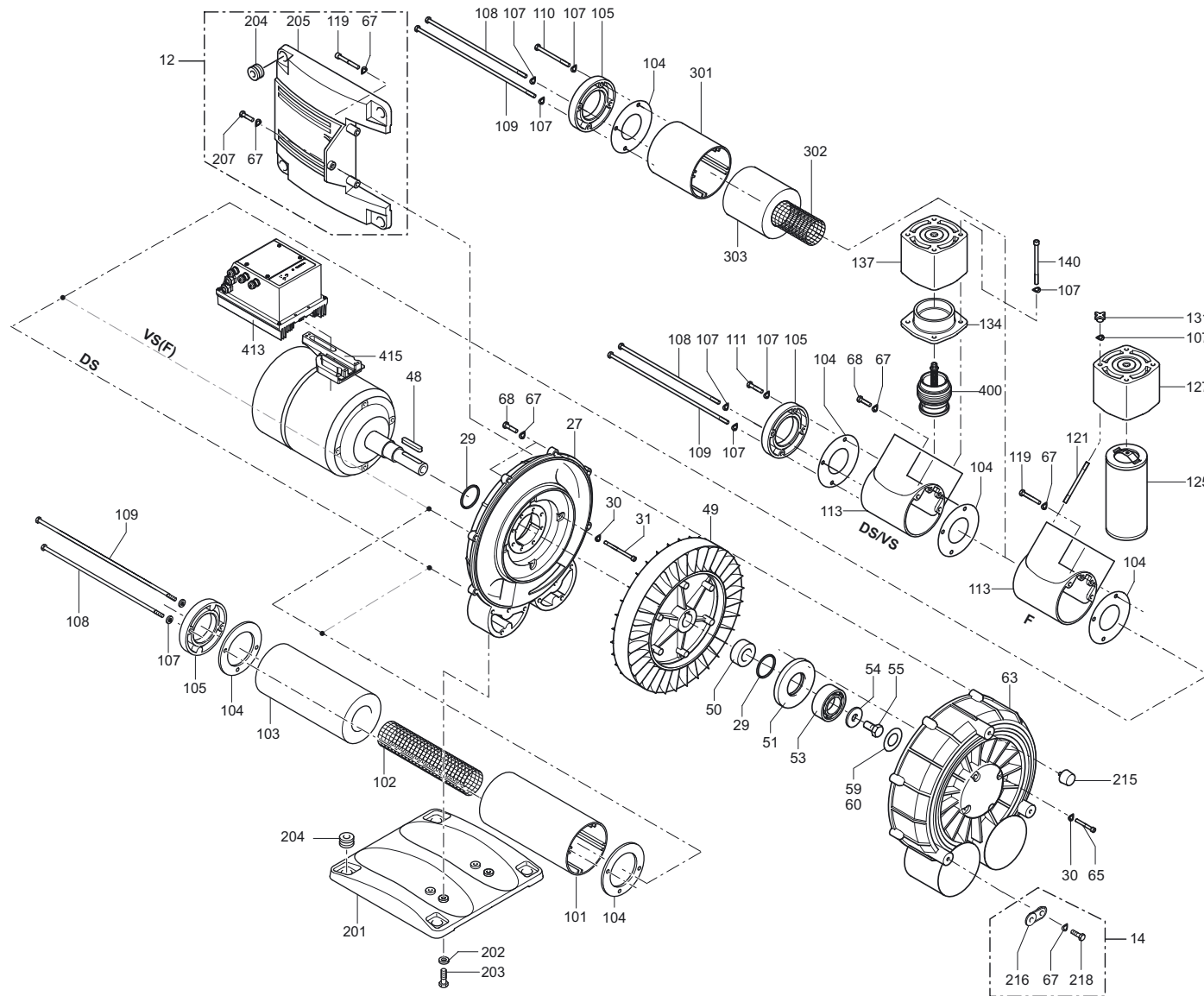
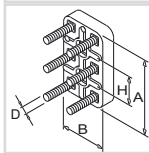
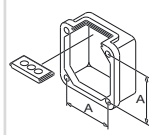
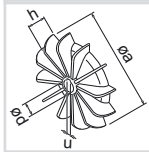
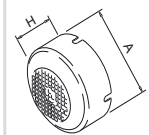

SV 8.190/1

SV 8.190/2

