

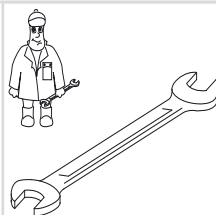

Gebr. Becker GmbH
Hölker Feld 29-31
D-42279 Wuppertal

Wartung
Maintenance
Entretien
Manutenzione
Mantenimiento



	Pos.	Menge Quantity Quantité Quantità Cantidad	Bestell-Nr. Ident No. No. Identification No. Identificazione No. de pedido	Bezeichnung Description Designation Designazione Descripción
SV 8.160	125	1*	909568 00000	Filterpatrone, Filter cartridge, Cartouche Filtrante, Cartuccia filtro, Cartucho de filtro

* erforderlich / necessary / nécessaire / necessaria / necesaria (F / DSF / VSF)



Ersatzteilliste
Spare parts list
Liste de pièces de rechange
Listino pezzi di ricambio
Lista de piezas de recambio
Lista de peças sobresselentes
Reserveonderdelenlijst
Reservedelsliste
Reservdelista

Reservedelsliste
Varaosaluettelo
Wykaz części zamiennych
Seznam náhradních dílů
Tartalékalkatrész lista
Κατάλογος ανταλλακτικών
Перечень запасных частей
备用零件目录
スペアパーツリスト

SV 8.160

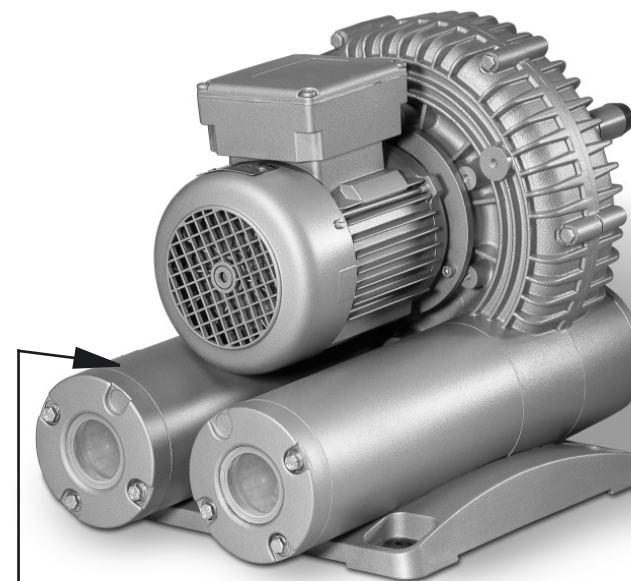

28000028700 09/2007

Index-B

 SERVICE	 D-42279 Wuppertal www.becker-international.com	No. B	year XXXX	Index Option
	CE	type SV 8.160-XX	Made in Germany	
	frequency	XXXX	Hz	
	speed	XXXX	min ⁻¹	
	power required	XXXX	kW	
	inlet capacity	XXXX	m ³ /h	
	pressure +	XXXX	mbar	
	vacuum -	XXXX	mbar	

(D) Service:
 Tel: +49 (0)202 697-171
 Fax: +49 (0)202 64 44 74
 E-Mail: info@becker-international.com
 www.becker-international.com

Pos.	Bestell Nr.	Beschreibung
8	570400 30300	UMBAUSATZ /1⇒ /2 (POS: 64, 69, 119, 181, 183)
12	515101 30200	FUSS - SEITLICH, KOMPLETT
14	515103 30200	GERÄTEFUSS, KOMPLETT (3x) ¹⁾
27	000100 30300	GEHÄUSE
29	911304 00000	DICHTUNGSSCHLAUCH
34	064900 30200	ZENTRIERBUCHSE
48	947738 00000	PASSFEDER
49	000602 30200	LAUFRAD
50	013900 30200	DISTANZBUCHSE
51	911432 00000	DISTANZSCHEIBE 25x33x0,2
52	911431 00000	DISTANZSCHEIBE 25x33x0,1
53	911429 00000	DISTANZSCHEIBE 25x33x0,05
54	911428 00000	DISTANZSCHEIBE 25x33x0,025
55	906612 50000	WÄLZLAGER
56	016800 30200	SPANNSCHEIBE
57	901805 00000	WELLENENDSCHRAUBE
63	000200 30300	GEHÄUSEDECKEL
64	951703 00000	FEDERSCHEIBE
65	945325 00000	INNENSECHSKANTSCHRAUBE
69	005600 30200	DECKEL
70	005602 30200	DECKEL
72	945222 00000	SECHSKANTSCHRAUBE
75	001102 30200	LAGERDECKEL
76	948503 00000	FEDERRING
77	945215 00000	SECHSKANTSCHRAUBE
78	928602 70000	DRUCKFEDER
79	917520 00000	PASSSCHEIBE
101	007400 19600	SCHALLDÄMPFERGEHÄUSE
102	907600 60000	SIEBROHR
103	907701 70000	DÄMPFER
104	907500 30200	DICHTUNG
105	007803 30200	GEWINDEFLANSCH
107	949451 00000	UNTERLEGSCHHEIBE
108	003803 94000	ZUGANKERSCHRAUBE
109	903812 01000	ZUGANKERSCHRAUBE
113	040100 30200	FILTERGEHÄUSE
115	945321 00000	INNENSECHSKANTSCHRAUBE
116	945225 00000	SECHSKANTSCHRAUBE
119	945376 00000	INNENSECHSKANTSCHRAUBE
125	909568 00000	FILTERPATRONE (1x) ¹⁾
126	951007 00000	STIFTSCHRAUBE
127	040200 19700	FILTERDECKEL
133	921503 00000	STERNGRIF
135	040201 19700	FILTERDECKEL
138	945373 00000	INNENSECHSKANTSCHRAUBE
139	016600 19600	ANSCHLUSSSTÜCK
181	015500 30300	REDUZIERSTÜCK
183	005601 30200	DECKEL
201	015100 30200	FUSS
202	947504 00000	UNTERLEGSCHHEIBE
203	945223 00000	SECHSKANTSCHRAUBE
204	015101 30200	FUSS-SEITLICH
206	945320 00000	INNENSECHSKANTSCHRAUBE
209	951906 00000	KABELTÜLLE
211	946944 00000	STIFTSCHRAUBE
213	012400 30200	ZWISCHENSTÜCK
215	741315 00000	GUMMIPUFFER
216	015101 79000	FUSS
301	007401 19600	SCHALLDÄMPFERGEHÄUSE



Pos.	Bestell Nr.	Beschreibung
302	907600 70100	SIEBROHR
303	907702 10000	DÄMPFER
316	903803 01000	ZUGANKERSCHRAUBE
400.1	733700 99581	VENTILEINSATZ, < 0,17BAR
400.2	733701 99581	VENTILEINSATZ, < 0,225/0,28BAR
400.3	733702 99581	VENTILEINSATZ, < 0,4BAR



Variante	/1-05 /2-05	MIT KORROSIONSSCHUTZ ²⁾
		UMBAUSATZ /1⇒ /2
	69	005610 30200 - DECKEL
	181	015510 30300 - REDUZIERSTÜCK
	183	005611 30200 - DECKEL
		VERDICHTER / VAKUUMPUMPE
	27	000110 30300 - GEHÄUSE
	49	000612 30200 - LAUFRAD
	63	000210 30300 - GEHÄUSEDECKEL
	70	005612 30200 - DECKEL
		SCHALLDÄMPFER
	101	007410 19600 - SCHALLDÄMPFERGEHÄUSE (2x)

¹⁾ erforderliche Bestellmenge / Wartung (F / DSF / VSF)

²⁾ variantenabhängige Bauteile

Zeichnung - siehe Anhang

Pos.	Ident No.	Description
8	570400 30300	CONVERSION SET /1⇒ /2 (POS: 64, 69, 119, 181, 183)
12	515101 30200	FOOT - LATERAL, COMPLETE
14	515103 30200	FOOT, COMPLETE (3x) ¹⁾
27	000100 30300	PUMP HOUSING
29	911304 00000	RUBBER SEAL RING
34	064900 30200	CENTRING BUSH
48	947738 00000	KEY
49	000602 30200	IMPELLER WHEEL
50	013900 30200	SPACER SLEEVE
51	911432 00000	SPACER 25X33X0,2
52	911431 00000	SPACER 25X33X0,1
53	911429 00000	SPACER 25X33X0,05
54	911428 00000	SPACER 25X33X0,025
55	906612 50000	ANTIFRICTION BEARING
56	016800 30200	IDLER
57	901805 00000	SHAFT END SCREW
63	000200 30300	HOUSING LID
64	951703 00000	LOCKING WASHER
65	945325 00000	HEXAGONAL SOCKET HEAD SCREW
69	005600 30200	COVER
70	005602 30200	LID
72	945222 00000	HEX HEAD SCREW
75	001102 30200	BEARING CAP
76	948503 00000	LOCK WASHER
77	945215 00000	HEX HEAD SCREW
78	928602 70000	PRESSURE SPRING
79	917520 00000	SHIM RING
101	007400 19600	SILENCER HOUSING
102	907600 60000	STRAINER TUBE
103	907701 70000	SILENCER SPONGE
104	907500 30200	GASKET
105	007803 30200	SCREWED FLANGE
107	949451 00000	WASHER
108	003803 94000	ANCHORING SCREW
109	903812 01000	ANCHORING SCREW
113	040100 30200	FILTER HOUSING
115	945321 00000	SOCKET HEAD SCREW
116	945225 00000	HEX-HEAD SCREW
119	945376 00000	SOCKET HEAD SCREW
125	909568 00000	FILTER CARTRIDGE (1x) ¹⁾
126	951007 00000	STUD
127	040200 19700	FILTER COVER
133	921503 00000	STAR GRIP
135	040201 19700	FILTER COVER
138	945373 00000	SOCKET HEAD SCREW
139	016600 19600	CONNECTING PIECE
181	015500 30300	REDUCING PIECE
183	005601 30200	COVER
201	015100 30200	FOOT
202	947504 00000	WASHER
203	945223 00000	HEX-HEAD SCREW
204	015101 30200	FOOT
206	945320 00000	SOCKET HEAD SCREW
209	951906 00000	RUBBER BUSHING
211	946944 00000	STUD
213	012400 30200	INTERMEDIATE PIECE
215	741315 00000	RUBBER BUFFER
216	015101 79000	FOOT
301	007401 19600	SILENCER HOUSING



Pos.	Ident No.	Description
302	907600 70100	STRAINER TUBE
303	907702 10000	SILENCER MATERIAL
316	903803 01000	ANCHORING SCREW
400.1	733700 99581	VALVE CORE, < 0,17BAR
400.2	733701 99581	VALVE CORE, < 0,225/0,28BAR
400.3	733702 99581	VALVE CORE, < 0,4BAR



/1-05 /2-05	WITH CORROSION PROTECTION ²⁾	
	570410 30300	CONVERSION KIT /1⇒ /2
69	005610 30200	- CAP
181	015510 30300	- REDUCING PIECE
183	005611 30200	- CAP
	571210 30300	BLOWER / VACUUM PUMP
27	000110 30300	- PUMP BODY
49	000612 30200	- IMPELLER
63	000210 30300	- HOUSING LID
70	005612 30200	- CAP
	57X310 30X00	SILENCER
101	007410 19600	- SILENCER HOUSING (2x)

¹⁾ necessary order quantity / maintenance (F / DSF / VSF)

²⁾ variant-dependent components

Drawing - see appendix

Pos.	No. Identification	Designation
8	570400 30300	ÉQUIPEMENT DE CONVERSION /1⇒ /2 (POS: 64, 69, 119, 181, 183)
12	515101 30200	PIED - LATÉRAL, COMPLET
14	515103 30200	PIED, COMPLET (3x) ¹⁾
27	000100 30300	CARTER
29	911304 00000	JOINT
34	064900 30200	BAGUE DE CENTRAGE
48	947738 00000	CLAVETTE
49	000602 30200	ROUE À AUBAGES
50	013900 30200	DOUILLE D'ÉCARTEMENT
51	911432 00000	DISQUE AJUSTAGE 25X33X0,2
52	911431 00000	DISQUE AJUSTAGE 25X33X0,1
53	911429 00000	DISQUE AJUSTAGE 25X33X0,05
54	911428 00000	DISQUE AJUSTAGE 25X33X0,025
55	906612 50000	ROULEMENT A BILLES
56	016800 30200	POULIE DE TENSION
57	901805 00000	VIS SIX-PANS
63	000200 30300	COUVERCLE DE CARTER
64	951703 00000	RONDELLE À RESSORT
65	945325 00000	VIS HEXAGONALE INTERNE
69	005600 30200	COUVERCLE
70	005602 30200	COUVERCLE
72	945222 00000	VIS SIX-PANS
75	001102 30200	CHAPEAU DE PALIER
76	948503 00000	RONDELLE ÉLASTIQUE
77	945215 00000	VIS SIX-PANS
78	928602 70000	RESSORT DE PRESSION
79	917520 00000	RONDELLE DE RÉGLAGE
101	007400 19600	CORPS DE LA SILENCIEUX
102	907600 60000	GRILLE POUR SILENCIEUX
103	907701 70000	MOUSSE POUR SILENCIEUX
104	907500 30200	JOINT
105	007803 30200	BRIDE FILETÉE
107	949451 00000	RONDELLE
108	003803 94000	VIS D'ANCRAGE
109	903812 01000	VIS D'ANCRAGE
113	040100 30200	BOITE POUR FILTRE
115	945321 00000	VIS HEXAGONALE INTERNE
116	945225 00000	VIS HEXAGONALE
119	945376 00000	VIS HEXAGONALE INTERNE
125	909568 00000	CARTOUCHE FILTRANTE (1x) ¹⁾
126	951007 00000	PRISONNIER
127	040200 19700	COUVERCLE DU FILTRE
133	921503 00000	POIGNEE-ETOILE
135	040201 19700	COUVERCLE DU FILTRE
138	945373 00000	VIS HEXAGONALE INTERNE
139	016600 19600	PIECE RACCORD
181	015500 30300	PIECE DE REDUCTION
183	005601 30200	COUVERCLE
201	015100 30200	PIED
202	947504 00000	RONDELLE
203	945223 00000	VIS HEXAGONALE
204	015101 30200	PIED-LATÉRAL
206	945320 00000	VIS HEXAGONALE INTERNE
209	951906 00000	PROTECTION EN CAOUTCHOUC
211	946944 00000	PRISONNIER
213	012400 30200	PLAQUE INTERMEDIARE
215	741315 00000	AMORTISSEUR EN CAOUTCHOUC
216	015101 79000	PIED
301	007401 19600	CARCASSE SILENCIEUX

Pos.	No. Identification	Designation
302	907600 70100	TUYAU-TAMIS
303	907702 10000	MATERIAL POUR SILENCIEUX
316	903803 01000	VIS
400.1	733700 99581	SOUPAPE, < 0,17BAR
400.2	733701 99581	SOUPAPE, < 0,225/0,28BAR
400.3	733702 99581	SOUPAPE, < 0,4BAR

Variante

/1-05	/2-05	AVEC PROT. CONTRE LA CORROSION ²⁾
		KIT DE TRANSFORMATION /1⇒ /2
69	005610 30200	- COUVERCLE
181	015510 30300	- PIECE DE REDUCTION
183	005611 30200	- COUVERCLE
	571210 30300	SOUFFLANTE / POMPE A VIDE
27	000110 30300	- CORP DE POMPE
49	000612 30200	- ROUE
63	000210 30300	- COUVERCLE DE CARTER
70	005612 30200	- COUVERCLE
	57X310 30X00	SILENCIEUX
101	007410 19600	- CARCASSE SILENCIEUX (2x)

¹⁾ quantité nécessaire / entretien (F / DSF / VSF)

²⁾ composants variante-dependantes

plan - voir annexe

Pos.	No. Identificazione	Designazione
8	570400 30300	ATTREZZATURA PER LA TRASFORMAZIONE /1⇒ /2 (POS: 64, 69, 119, 181, 183,)
12	515101 30200	PIEDE - LATERALE, COMPLETO
14	515103 30200	PIEDE, COMPLETO (3x) ¹⁾
27	000100 30300	CARCASSA
29	911304 00000	GUARNIZIONE
34	064900 30200	BOCCOLA DI CENTRAGGIO
48	947738 00000	CHIAVETTA
49	000602 30200	RUOTA A PALETTE
50	013900 30200	ANELLO DISTANZIATORE
51	911432 00000	DISCO GIUOCO 25X33X0,2
52	911431 00000	DISCO GIUOCO 25X33X0,1
53	911429 00000	DISCO GIUOCO 25X33X0,05
54	911428 00000	DISCO GIUOCO 25X33X0,025
55	906612 50000	CUSCINETTO A SFERA
56	016800 30200	PULEGGIA DI TENSIONE
57	901805 00000	VITE ESAGONALE
63	000200 30300	COPERCHIO DELLA CARCASSA
64	951703 00000	DISCO A MOLLA
65	945325 00000	VITE ESAGONALE INTERNA
69	005600 30200	COPERCHIO
70	005602 30200	COPERCHIO
72	945222 00000	VITE ESAGONALE
75	001102 30200	CAPPELLO DEL CUSCINETTO
76	948503 00000	ANELLO A MOLLA
77	945215 00000	VITE ESAGONALE
78	928602 70000	MOLLA DI COMPRESSIONE
79	917520 00000	DISCO DI COMPENSAZIONE
101	007400 19600	CARCASSA SILENZIATORE
102	907600 60000	TUBO-CRIVELLO
103	907701 70000	MATERIALE PER SILENZIATORE
104	907500 30200	GIUNTO
105	007803 30200	FLANGIA FILETTATA
107	949451 00000	RONDELLA
108	003803 94000	CHIAVARDA D'ANCORAGGIO
109	903812 01000	CHIAVARDA D'ANCORAGGIO
113	040100 30200	CONTENITORE FILTRO A CARTUCCIA
115	945321 00000	VITE ESAGONALE INTERNA
116	945225 00000	VITE ESAGONALE
119	945376 00000	VITE ESAGONALE INTERNA
125	909568 00000	CARTUCCIA FILTRO (1x) ¹⁾
126	951007 00000	L'ASTA A VITE
127	040200 19700	COPERCHIO FILTRO
133	921503 00000	MANOPOLA A CROCIERA
135	040201 19700	COPERCHIO FILTRO
138	945373 00000	VITE ESAGONALE INTERNA
139	016600 19600	PEZZI RACCORDI
181	015500 30300	GIUNTO DI REDUZIONE
183	005601 30200	COPERCHIO
201	015100 30200	PIEDE
202	947504 00000	RONDELLA
203	945223 00000	VITE ESAGONALE
204	015101 30200	PIEDE-LATERALE
206	945320 00000	VITE ESAGONALE INTERNA
209	951906 00000	PROTEZIONE IN GOMMA
211	946944 00000	L'ASTA A VITE
213	012400 30200	PIASTRA INTERMEDIA
215	741315 00000	AMMORTIZZATORE IN GOMMA
216	015101 79000	PIASTRA DI APPOGGIO
301	007401 19600	CARCASSA SILENZIATORE

Pos.	No. Identificazione	Designazione
302	907600 70100	TUBO-CRIVELLO
303	907702 10000	MATERIALE PER SILENZIATORE
316	903803 01000	VITE
400.1	733700 99581	VALVOLA, < 0,17BAR
400.2	733701 99581	VALVOLA, < 0,225/0,28BAR
400.3	733702 99581	VALVOLA, < 0,4BAR

Variante	/1-05	CON PROTEZIONE ANTI-CORROSIONE ²⁾	
	/2-05		
		570410 30300	SET DI TRASFORMAZIONE /1⇒ /2
	69	005610 30200	- COPERCHIO
	181	015510 30300	- GIUNTO DI REDUZIONE
	183	005611 30200	- COPERCHIO
		571210 30300	SOFFIANTE / POMPA A VUOTO
	27	000110 30300	- CARCASSA
	49	000612 30200	- GIRANTE
	63	000210 30300	- COPERCHIO DELLA CARCASSA
	70	005612 30200	- COPERCHIO
		57X310 30X00	SILENZIATORE
	101	007410 19600	- CARCASSA SILENZIATORE

¹⁾ quantità di ordinazione necessari / manutenzione (F / DSF / VSF)

²⁾ componenti variante-dipendenti

Disegno - vedere allegato

Pos.	No. De pedido	Descripción	
8	570400 30300	EQUIPO PARA LA CONVERSIÓN /1⇒ /2 (POS: 64, 69, 119, 181, 183)	
12	515101 30200	PIE - LATERAL, COMPLETO	
14	515103 30200	PIE, COMPLETO (3x) ¹⁾	
27	000100 30300	CARCASA	
29	911304 00000	MANGUERA DE JUNTA	
34	064900 30200	MANGUITO DE CENTRADO	
48	947738 00000	LENGÜETA DE AJUSTE	
49	000602 30200	RUEDA CORREDERA	
50	013900 30200	CASQUILLO DISTANCIADOR	
51	911432 00000	ARANDELA DISTANCIADORA 25X33X0,2	
52	911431 00000	ARANDELA DISTANCIADORA 25X33X0,1	
53	911429 00000	ARANDELA DISTANCIADORA 25X33X0,05	
54	911428 00000	ARANDELA DISTANCIADORA 25X33X0,025	
55	906612 50000	COJINETE DE RODAMIENTO	
56	016800 30200	POLEA TENSORA	
57	901805 00000	TORNILLO DE CABEZA HEXAGONAL	
63	000200 30300	CUBIERTA DE CARCASA	
64	951703 00000	ARANDELA ELÁSTICA	
65	945325 00000	TORNILLO HEXAGONAL INTERIOR	
69	005600 30200	TAPA	
70	005602 30200	TAPA	
72	945222 00000	TORNILLO DE CABEZA HEXAGONAL	
75	001102 30200	TAPA DEL COJINETE	
76	948503 00000	ARANDELA DE MUELLE	
77	945215 00000	TORNILLO DE CABEZA HEXAGONAL	
78	928602 70000	MUELLE DE PRESIÓN	
79	917520 00000	ARANDELA DE AJUSTE	
101	007400 19600	CARCASA DE SILENCIADOR	
102	907600 60000	TUBO DE CRIBA	
103	907701 70000	AMORTIGUADOR	
104	907500 30200	JUNTA	
105	007803 30200	BRIDA ROSCADA	
107	949451 00000	ARANDELA	
108	003803 94000	TORNILLO DE ANCLAJE	
109	903812 01000	TORNILLO DE ANCLAJE	
113	040100 30200	CARCASA DE FILTRO	
115	945321 00000	TORNILLO HEXAGONAL INTERIOR	
116	945225 00000	TORNILLO DE CABEZA HEXAGONAL	
119	945376 00000	TORNILLO HEXAGONAL INTERIOR	
125	909568 00000	CARTUCHO (1x) ¹⁾	
126	951007 00000	ESPÁRRAGO	
127	040200 19700	FILTRO TAPA	
133	921503 00000	EMPUÑADURA DE ESTRELLA	
135	040201 19700	TAPA DE FILTRO	
138	945373 00000	TORNILLO HEXAGONAL INTERIOR	
139	016600 19600	PIEZA DE EMPALME	
181	015500 30300	PIEZA DE REDUCCIÓN	
183	005601 30200	TAPA	
201	015100 30200	PIE	
202	947504 00000	ARANDELA	
203	945223 00000	TORNILLO DE CABEZA HEXAGONAL	
204	015101 30200	PIE DE APARATO - LATERAL	
206	945320 00000	TORNILLO HEXAGONAL INTERIOR	
209	951906 00000	BOQUILLA DE CABLE	
211	946944 00000	ESPÁRRAGO	
213	012400 30200	PIEZA INTERMEDIA	
215	741315 00000	AMORTIGUADOR DE GOMA	
216	015101 79000	PIE DE APARATO	
301	007401 19600	CARCASA DE SILENCIADOR	

Pos.	No. De pedido	Descripción	
302	907600 70100	TUBO DE CRIBA	
303	907702 10000	AMORTIGUADOR PANTARIN	
316	903803 01000	TORNILLO TIRANTE	
400.1	733700 99581	VÁLVULA, < 0,17BAR	
400.2	733701 99581	VÁLVULA, < 0,225/0,28BAR	
400.3	733702 99581	VÁLVULA, < 0,4BAR	

Variante

/1-05 /2-05	CON PROTECCIÓN CONTRA LA CORROSIÓN ²⁾	
	570410 30300	EQUIPO PARA LA CONVERSIÓN /1⇒ /2
69	005610 30200	- TAPA
181	015510 30300	- PIEZA DE REDUCCIÓN
183	005611 30200	- TAPA
	571210 30300	SOPLANTES / BOMBA DE VACIO
27	000110 30300	- CARCASA
49	000612 30200	- RUEDA CORREDERA
63	000210 30300	- TAPA DE CARCASA
70	005612 30200	- TAPA
	57X310 30X00	SILENCIADOR
101	007410 19600	- CARCASA DE SILENCIADOR (2x)

¹⁾ cantidad necesario / mantenimiento (F / DSF / VSF)

²⁾ componentes variante-dependientes

Dibujo - véase apéndice



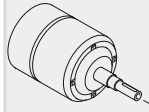

SERVICE ?

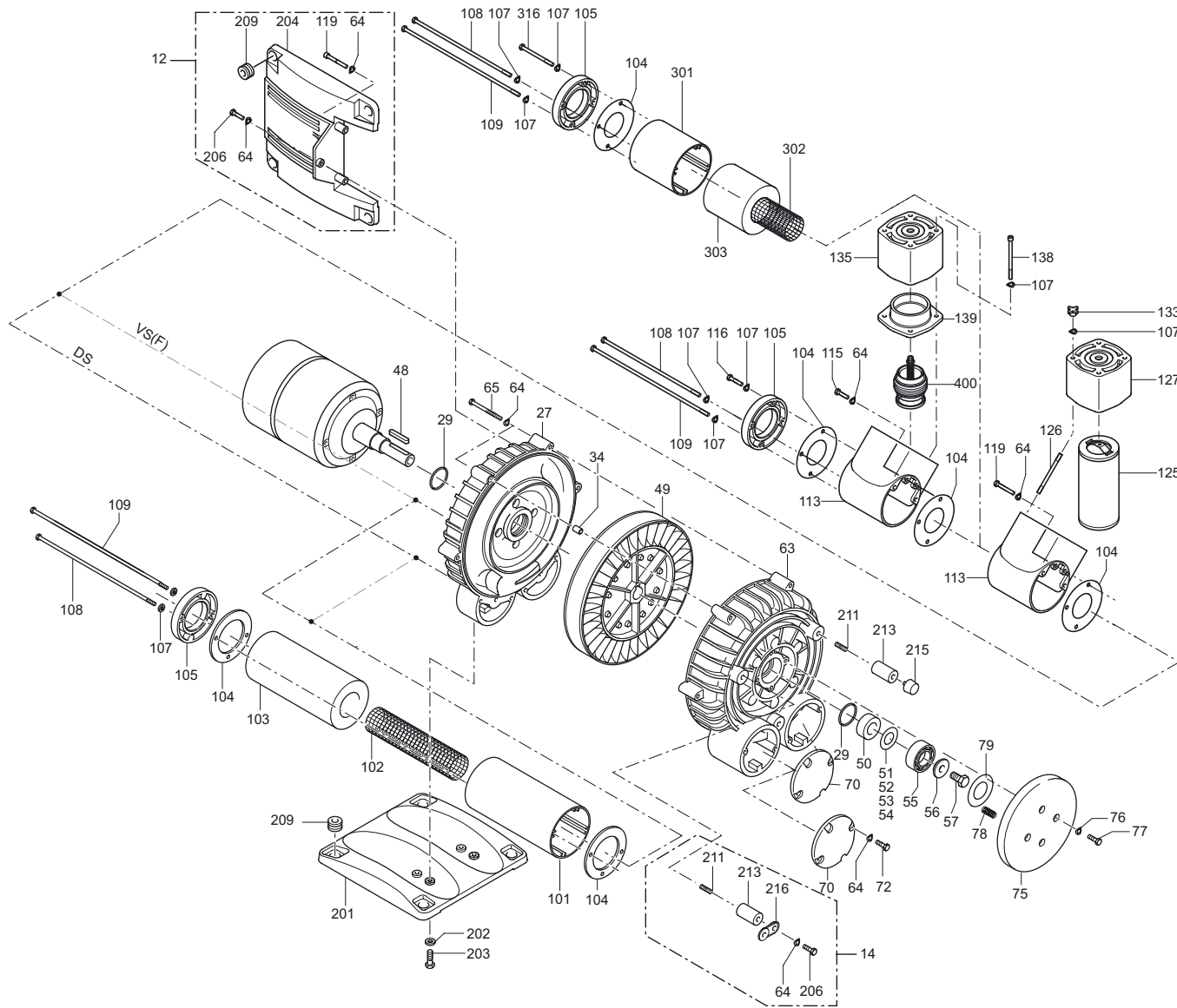
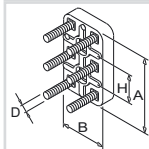
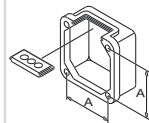
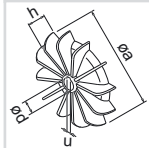
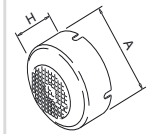

SV 8.160/1



SV 8.160/2

SV 8.160/2



SV 8.160/5

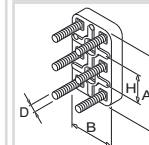
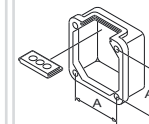
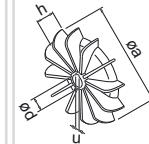
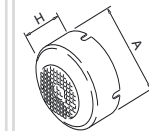
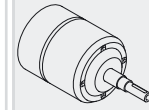
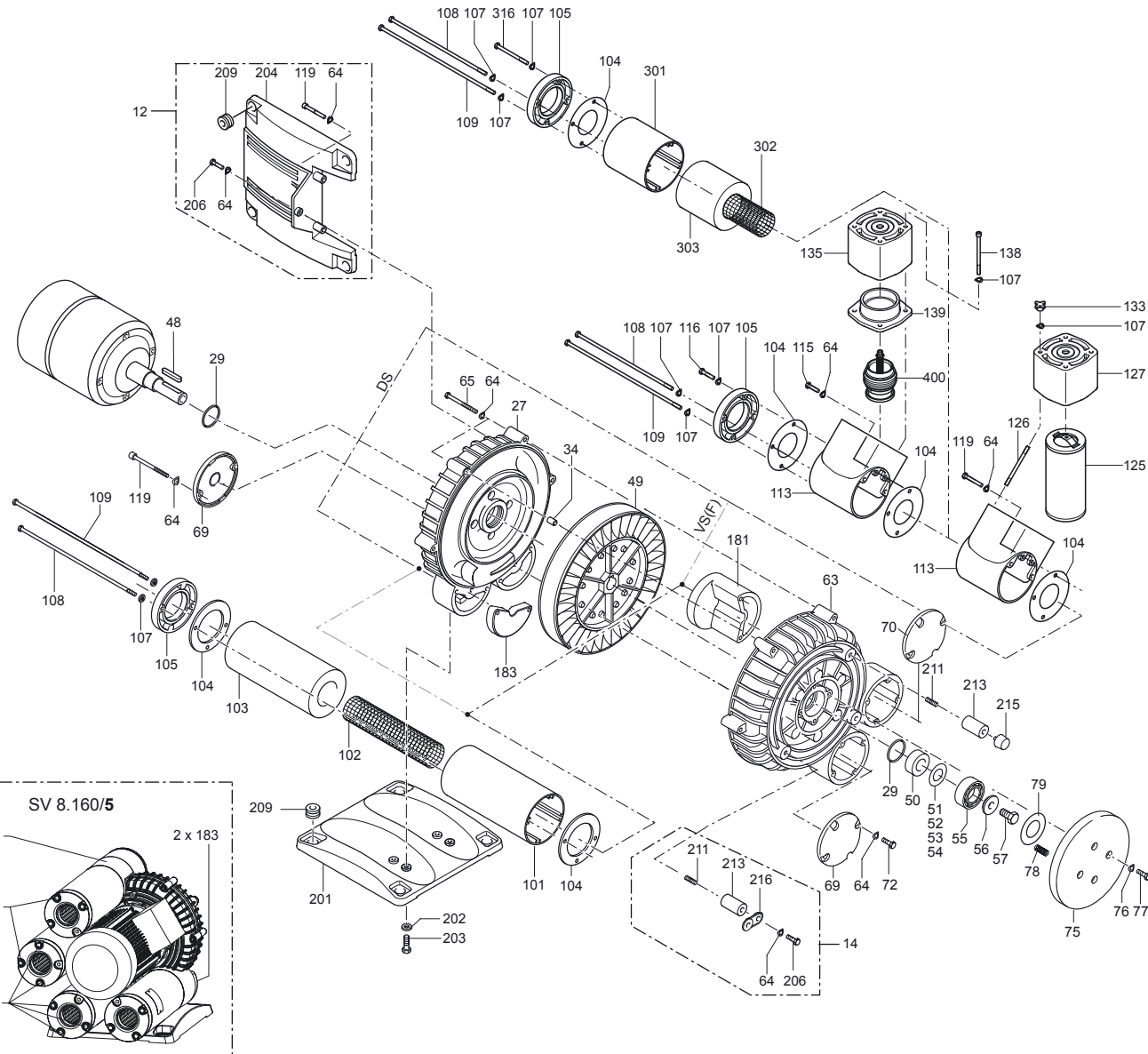

SV 8.160/1