

SV 5.300/1

Ersatzteilliste
 Spare parts list
 Liste de pièces de rechange
 Listino pezzi di ricambio
 Lista de piezas de recambio
 Lista de peças sobresselentes
 Reserveonderdelenlijst
 Reservdelistsite
 Reservdelslista

Reservdelistsite
 Varaosaluettelo
 Wykaz części zamiennych
 Seznam náhradních dílů
 Tartalékalkatrész lista
 Κατάλογος ανταλλακτικών
 Yedek parça listesi
 Перечень запасных частей
 备用零件目录
 スペアパーツリスト

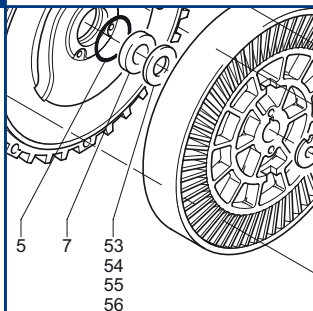

SERVICE

BECKER
D-42279 Wuppertal
www.becker-international.com

year

No **A** Index Variante

type **SV 5.300-XX**

frequency	<input type="text" value="XXXX"/>	Hz
speed	<input type="text" value="XXXX"/>	min ⁻¹
power required	<input type="text" value="XXXX"/>	kW
inlet capacity	<input type="text" value="XXXX"/>	m ³ /h
pressure +	<input type="text" value="XXXX"/>	mbar
vacuum -	<input type="text" value="XXXX"/>	mbar

Made in Germany

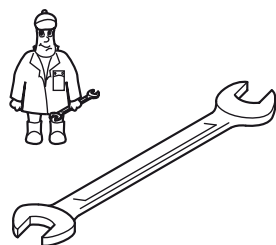

Wartung
 Maintenance
 Entretien
 Manutenzione
 Mantenimiento

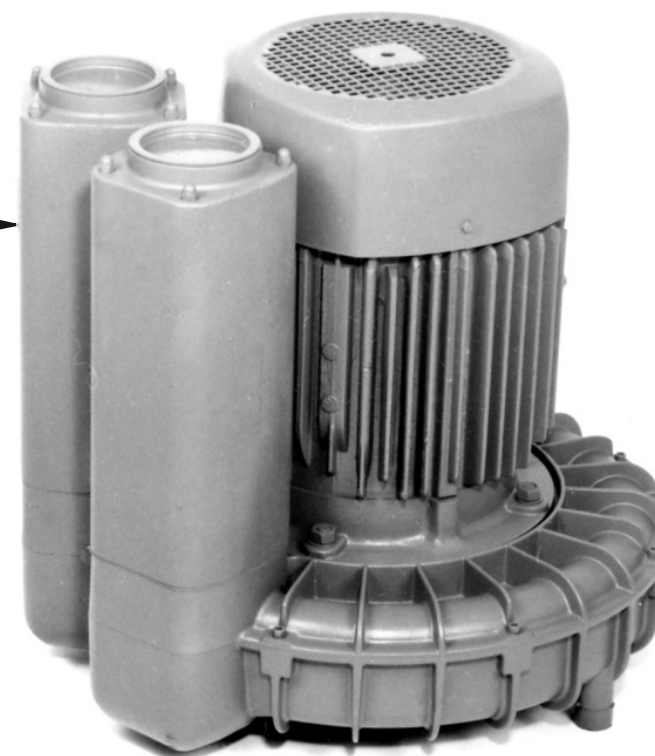

SERVICE
www.becker-international.com
 Sales and service network

SV 5.300/1 Standard



Variante



SV 5.300/1-XX

① /1-05
 Korrosionsschutz
 corrosion protection
 protection contre la corrosion
 protezione anti-corrosione
 protección contra la corrosión

② /1-18
 Korrosionsschutz
 corrosion protection
 protection contre la corrosion
 protezione anti-corrosione
 protección contra la corrosión

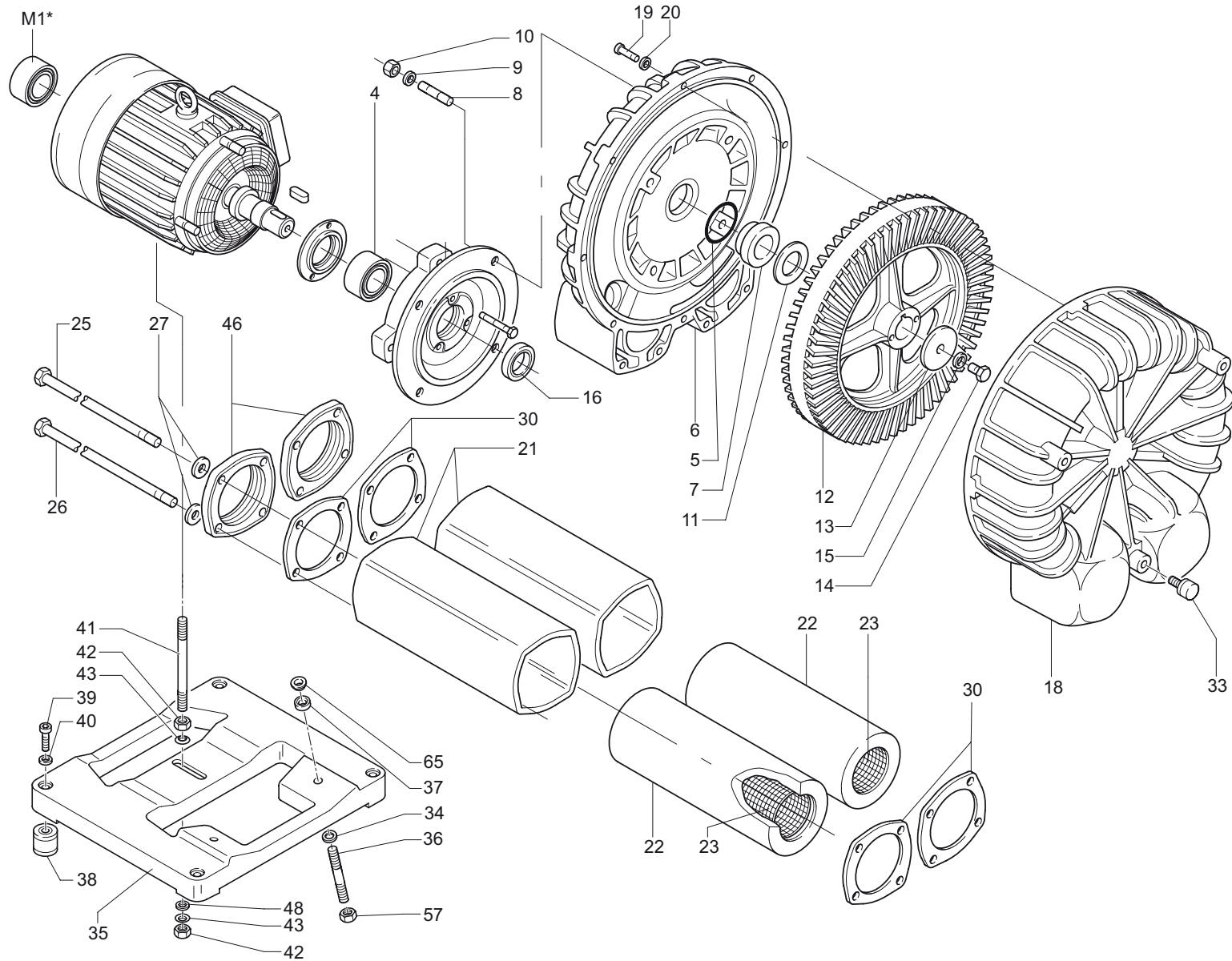

SERVICE ?

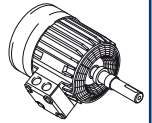

C = ? μ F
 U = ? V

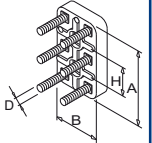
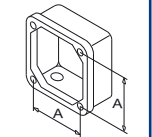
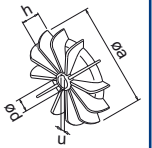
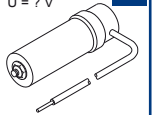

A INDEX	Pos.	Bestell Nr.	Beschreibung	
SV 5.300	4	947736 00000	WÄLZLAGER 3208 2 RS C3 TA	
	5	906612 10000	DICHTUNGSSCHLAUCH	
	6	911310 00000	GEHÄUSE	
	7	000102 92000	DISTANZBUCHSE	
	8	013904 92000	STIFTSCHRAUBE	
	9	000600 14400	FEDERSCHEIBE	
	10	001900 23000	SECHSKANTMUTTER	
	11	001800 23000	SATZ DISTANZSCHEIBEN	
	12	015500 92000	LAUFRAD	
	13	945363 00000	SPANNSCHEIBE	
	14	951703 00000	SECHSKANTSCHRAUBE	
	15	000201 92000	FEDERRING	
	16	945320 00000	WELLENDICHRING	
	18	951703 00000	GEHÄUSEDECKEL	
	19	007405 92000	INNENSECHSKANTSCHRAUBE	
	20	007700 92000	FEDERSCHEIBE	
	21	007701 92000	SCHALLDÄMPFERGEHÄUSE	
	22	007600 92000	DÄMPFER	
	23	007601 92000	SIEBROHR	
	25	003801 79000	ZUGANKERSCHRAUBE	
	26	903802 01000	ZUGANKERSCHRAUBE	
	27	951703 00000	FEDERSCHEIBE	
	30	005600 92000	DICHTUNG	
	33	945320 00000	GUMMIPUFFER	
	34	945364 00000	U-SCHEIBE	
	35	005601 92000	GERÄTEFUSS	
	36	945319 00000	STIFTSCHRAUBE	
	37	951703 00000	KEGELPFANNE	
	38	607500 92000	GUMMIPUFFER	
	39	741315 00000	INNENSECHSKANTSCHRAUBE	
	40	015100 92000	FEDERSCHEIBE	
	41	945321 00000	STIFTSCHRAUBE	
	42	951703 00000	SECHSKANTMUTTER	
43	607500 92000	FEDERSCHEIBE		
46	007800 92000	ANSCHLUSSFLANSCH		
48	001101 83000	U-SCHEIBE		
57	945309 00000	SECHSKANTMUTTER		
65	951704 00000	KUGELSCHIBE		
M1	911465 00000	MOTORLAGER 6306 ¹⁾		
M1	911466 00000	MOTORLAGER 6308 ¹⁾		
M1	911467 00000	MOTORLAGER 6208 ¹⁾		
M1	607500 92000	MOTORLAGER 6309 ¹⁾		
M1	015101 79000	MOTORLAGER 6310 ¹⁾		

¹⁾ motorabhängig / Lager sind mit Spezialfett gefüllt. Nur durch Original der Firma Gebr. Becker ersetzen.

A INDEX	Pos.	Ident No.	Description	
SV 5.300	4	947736 00000	BALL BEARING 3208 2 RS C3 TA	
	5	906612 10000	SEAL	
	6	911310 00000	PUMP BODY	
	7	000102 92000	SPACER	
	8	013904 92000	STUD	
	9	000600 14400	SPRING DISC	
	10	001900 23000	HEX. NUT	
	11	001800 23000	SET DISTANCE DISC	
	12	015500 92000	IMPELLER	
	13	945363 00000	CLAMPING DISC	
	14	951703 00000	HEX-HEAD SCREW	
	15	000201 92000	SPRING WASHER	
	16	945320 00000	SHAFT-SEALING RING	
	18	951703 00000	HOUSING LID	
	19	007405 92000	SOCKET HEAD SCREW	
	20	007700 92000	LOCKING WASHER	
	21	007701 92000	SILENCER HOUSING	
	22	007600 92000	SILENCER SPONGE	
	23	007601 92000	STRAINER TUBE	
	25	003801 79000	ANCHORING SCREW	
	26	903802 01000	ANCHORING SCREW	
	27	951703 00000	LOCKING WASHER	
	30	005600 92000	GASKET	
	33	945320 00000	RUBBER BUFFER	
	34	945364 00000	WASHER	
	35	005601 92000	FOOT	
	36	945319 00000	STUD	
	37	951703 00000	CONICAL SEAT	
	38	607500 92000	RUBBER BUFFER	
	39	741315 00000	SOCKET HEAD SCREW	
	40	015100 92000	SPRING DISC	
	41	945321 00000	STUD	
	42	951703 00000	HEX.NUT	
43	607500 92000	SPRING DISC		
46	007800 92000	CONNECTING FLANGE		
48	001101 83000	WASHER		
57	945309 00000	HEX.NUT		
65	951704 00000	SPHERICAL WASHER		
M1	911465 00000	BALL BEARING 6306 ¹⁾		
M1	911466 00000	BALL BEARING 6308 ¹⁾		
M1	911467 00000	BALL BEARING 6208 ¹⁾		
M1	607500 92000	BALL BEARING 6309 ¹⁾		
M1	015101 79000	BALL BEARING 6310 ¹⁾		

¹⁾ motor-dependent / Bearings are filled with special grease. Only be replaced by Gebrüder Beckers original.

A INDEX	Pos.	No. Identification	Designation		
SV 5.300	4	947736 00000	ROULEMENT A BILLES 3208 2 RS C3 TA		
	5	906612 10000	JOINT		
	6	911310 00000	CORP DE POMPE		
	7	000102 92000	DOUILLE		
	8	013904 92000	PRISONNIER		
	9	000600 14400	DISQUE DE RESSORT		
	10	001900 23000	ECROU A 6 PANS		
	11	001800 23000	JEU DISQUE DE TOLERANCE		
	12	015500 92000	ROUE		
	13	945363 00000	DISQUE DE SERRAGE		
	14	951703 00000	VIS HEXAGONALE		
	15	000201 92000	ANNEAU-RESSORT		
	16	945320 00000	BAGUE D'ETANCHEITE P.L'AXE		
	18	951703 00000	COUVERCLE		
	19	007405 92000	VIS HEXAGONALE INTERNE		
	20	007700 92000	RONDELLE À RESSORT		
	21	007701 92000	CARCASSE SILENCIEUX		
	22	007600 92000	MOUSSE POUR SILENCIEUX		
	23	007601 92000	GRILLE POUR SILENCIEUX		
	25	003801 79000	VIS D'ANCRAGE		
	26	903802 01000	VIS D'ANCRAGE		
	27	951703 00000	RONDELLE À RESSORT		
	30	005600 92000	JOINT		
	33	945320 00000	AMORTISSEUR EN CAOUTCHOUC		
	34	945364 00000	RONDELLE		
	35	005601 92000	PIED		
	36	945319 00000	PRISONNIER		
	37	951703 00000	RONDELLE A ROTULE CONCAVE		
	38	607500 92000	AMORTISSEUR EN CAOUTCHOUC		
	39	741315 00000	VIS HEXAGONALE INTERNE		
	40	015100 92000	DISQUE DE RESSORT		
	41	945321 00000	PRISONNIER		
	42	951703 00000	ECROU A 6 PANS		
43	607500 92000	DISQUE DE RESSORT			
46	007800 92000	BRIDE DE RACCORDEMENT			
48	001101 83000	RONDELLE			
57	945309 00000	ECROU A 6 PANS			
65	951704 00000	RONDELLE A PORTEE SPHERIQUE			
M1	911465 00000	ROULEMENT A BILLES 6306 ¹⁾			
M1	911466 00000	ROULEMENT A BILLES 6308 ¹⁾			
M1	911467 00000	ROULEMENT A BILLES 6208 ¹⁾			
M1	607500 92000	ROULEMENT A BILLES 6309 ¹⁾			
M1	015101 79000	ROULEMENT A BILLES 6310 ¹⁾			



¹⁾dépendant du moteur / Les roulements sont remis d'une graisse spéciale. N'utiliser que de la graisse d'origine de Gebrüder Becker.

A INDEX	Pos.	No. Identificazione	Designazione		
SV 5.300	4	947736 00000	CUSCINETTO A SFERA 3208 2 RS C3 TA		
	5	906612 10000	GUARNIZIONE		
	6	911310 00000	CARCASSA		
	7	000102 92000	BOCCOLA		
	8	013904 92000	L'ASTA A VITE		
	9	000600 14400	DISCO A MOLLA		
	10	001900 23000	DADO ESAGONALE		
	11	001800 23000	SERIE DISCO GIUOCO		
	12	015500 92000	GIRANTE		
	13	945363 00000	DISCO DI FISSAGGIO		
	14	951703 00000	VITE ESAGONALE		
	15	000201 92000	ANELLO A MOLLA		
	16	945320 00000	GUARNIZIONE PER L'ALBERO		
	18	951703 00000	COPERCHIO		
	19	007405 92000	VITE ESAGONALE INTERNA		
	20	007700 92000	DISCO A MOLLA		
	21	007701 92000	CARCASSA SILENZIATORE		
	22	007600 92000	MATERIALE PER SILENZIATORE		
	23	007601 92000	TUBO-CRIVELLO		
	25	003801 79000	CHIAVARDA D'ANCORAGGIO		
	26	903802 01000	CHIAVARDA D'ANCORAGGIO		
	27	951703 00000	DISCO A MOLLA		
	30	005600 92000	GUARNIZIONE		
	33	945320 00000	AMMORTIZZATORE IN GOMMA		
	34	945364 00000	RONDELLA		
	35	005601 92000	PIASTRA DI APPOGGIO		
	36	945319 00000	L'ASTA A VITE		
	37	951703 00000	CROGIOLO		
	38	607500 92000	AMMORTIZZATORE IN GOMMA		
	39	741315 00000	VITE ESAGONALE INTERNA		
	40	015100 92000	DISCO A MOLLA		
	41	945321 00000	L'ASTA A VITE		
	42	951703 00000	DADO ESAGONALE		
43	607500 92000	DISCO A MOLLA			
46	007800 92000	FLANGIA DI RACCORDO			
48	001101 83000	RONDELLA			
57	945309 00000	DADO ESAGONALE			
65	951704 00000	CALOTTE			
M1	911465 00000	CUSCINETTO A SFERA 6306 ¹⁾			
M1	911466 00000	CUSCINETTO A SFERA 6308 ¹⁾			
M1	911467 00000	CUSCINETTO A SFERA 6208 ¹⁾			
M1	607500 92000	CUSCINETTO A SFERA 6309 ¹⁾			
M1	015101 79000	CUSCINETTO A SFERA 6310 ¹⁾			

¹⁾dipende del motore / I cuscinetti sono riempiti di grasso speciale. Eseguire il reingrassaggio solo con grasso originale della Gebrüder Becker.

A INDICE	Pos.	No. De pedido	Descripción	
SV 5.300	4	906611 10000	COJINETE DE RODAMIENTO 3208 2 RS C3 TA	
	5	911317 00000	MANGUERA DE JUNTA	
	6	000100 16600	CARCASA	
	7	013901 16900	CASQUILLO DISTANCIADOR	
	8	946937 00000	ESPÁRRAGO	
	9	951705 00000	ARANDELA ELÁSTICA	
	10	947107 00000	TUERCA HEXAGONAL	
	11	511400 16600	JUEGO DE ARANDELAS DISTANCIADORAS	
	12	000600 16600	RUEDA CORREDERA	
	13	016800 16600	ARANDELA TENSORA	
	14	945243 00000	TORNILLO DE CABEZA HEXAGONAL	
	15	948509 00000	ARANDELA DE MUELLE	
	16	906578 00000	ANILLO DE JUNTA DE ÁRBOL	
	18	000200 16600	TAPA DE CARCASA	
	19	945320 00000	TORNILLO HEXAGONAL INTERIOR	
	20	951703 00000	ARANDELA ELÁSTICA	
	21	007420 16600	CARCASA DE SILENCIADOR	
	22	007700 16600	AMORTIGUADOR	
	23	007600 57000	TUBO DE CRIBA	
	25	003807 94000	TORNILLO DE ANCLAJE	
	26	003803 94000	TORNILLO DE ANCLAJE	
	27	951703 00000	ARANDELA ELÁSTICA	
	30	007500 16600	JUNTA	
	33	741310 10000	AMORTIGUADOR DE GOMA	
	34	949450 00000	ARANDELA	
	35	015100 16600	PIE DE APARATO	
	36	951011 00000	ESPÁRRAGO	
	37	950352 00000	CAZOLETA	
	38	741302 00000	AMORTIGUADOR DE GOMA	
	39	945331 00000	TORNILLO HEXAGONAL INTERIOR	
	40	951707 00000	ARANDELA ELÁSTICA	
	41	951051 00000	ESPÁRRAGO	
	42	947106 00000	TUERCA HEXAGONAL	
	43	951710 00000	ARANDELA ELÁSTICA	
	46	007800 16600	BRIDA DE EMPALME	
	48	949410 00000	ARANDELA	
	57	947105 00000	TUERCA HEXAGONAL	
	65	950351 00000	ARANDELA ESFÉRICA	
	M1	906639 00000	COJINETE DE RODAMIENTO 6306 ¹⁾	
	M1	906635 00000	COJINETE DE RODAMIENTO 6308 ¹⁾	
	M1	906616 40000	COJINETE DE RODAMIENTO 6208 ¹⁾	
	M1	906615 50000	COJINETE DE RODAMIENTO 6309 ¹⁾	
	M1	906615 70000	COJINETE DE RODAMIENTO 6310 ¹⁾	

¹⁾ dependiente del motor / Los rodamientos estan rellenos de grasa especial. Sólo reemplazar por grasa original de Gebrüder Becker.

SV5.300/1-XX Variante 	Pos. ²⁾	Bestell Nr. / Ident No. / No. Identification / No. Identificazione / No. De pedido		Beschreibung / Description / Designation / Designazione / Desripcion
				
① /1-05 ② /1-18 Korrosionsschutz corrosion protection protection contre la corrosion protezione anti-corrosione protección contra la corrosión	6	000110 16600	000100 16600	GEHÄUSE / PUMP BODY / CORP DE POMPE / CARCASSA / CARCASA
	12	000610 16600	000600 16600	LAUFRAD / IMPELLER / ROUE / GIRANTE / RUEDA CORREDERA
	13	016810 16600	016800 16600	SPANNSCHEIBE / CLAMPING DISC / DISQUE DE SERRAGE / DISCO DI FISSAGGIO / ARANDELA TENSORA
	18	000210 16600	948509 00000	GEHÄUSEDECKEL / HOUSING LID / COUVERCLE / COPERCHIO / TAPA DE CARCASA
	21	007412 16600	007420 16600	SCHALLDÄMPFERGEHÄUSE / SILENCER HOUSING / CARCASSE SILENCIEUX / CARCASSA SILENZIATORE / CARCASA DE SILENCIADOR
	23	007610 57000	007600 57000	SIEBRÖHR / STRAINER TUBE / GRILLE POUR SILENCIEUX / TUBO-CRIVELLO / TUBO DE CRIBA

²⁾ variantenabhängige Bauteile / variant-dependent components / composants variante-dependantes / componenti variante-dispendenti / componentes variante-dependientes