

**SV 5.250/1**  
**SV 5.250/2**

Ersatzteilliste  
Spare parts list  
Liste de pièces de rechange  
Listino pezzi di ricambio  
Lista de piezas de recambio  
Reserveonderdelenlijst  
Reservedelsliste  
Reservdelslista

Reservedelsliste  
Varaosaluettelo  
Wykaz części zamiennych  
Seznam náhradních dílů  
Tartalékalkatrész lista  
Κατάλογος ανταλλακτικών  
Yedek parça listesi  
Перечень запасных частей  
备用零件目录  
スペアパーツリスト

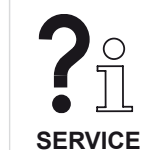
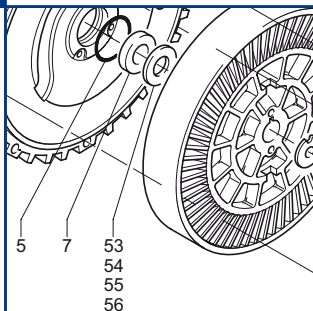

SERVICE

**BECKER**

D-42279 Wuppertal  
www.becker-international.com

CE

year	XXXX
No	E
type	SV 5.250-XX
frequency	XXXX Hz
speed	XXXX min <sup>-1</sup>
power required	XXXX kW
inlet capacity	XXXX m <sup>3</sup> /h
pressure +	XXXX mbar
vacuum -	XXXX mbar

Index  
Variante

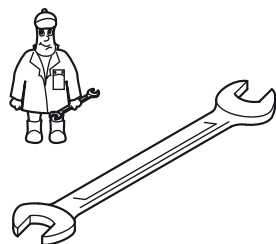

Wartung  
Maintenance  
Entretien  
Manutenzione  
Mantenimiento



**SERVICE**  
[www.becker-international.com](http://www.becker-international.com)  
Sales and service network

SV 5.250/1  
SV 5.250/2

Standard



Variante



SV 5.250/X-XX

① /1-01  
mit Schalldämpferfuß  
with foot / silencer combination  
avec combinaison pied / silencieux  
con combinazione piede / silenziatore  
con combinación pie / silenciador

② /1-05  
Korrosionsschutz  
corrosion protection  
protection contre la corrosion  
protezione anti-corrosione  
protección contra la corrosión

② /2-10  
mit Sonderschalldämpfer  
with special silencer  
avec silencieux spéciale  
con silenziatore speciale  
con silenciador especial

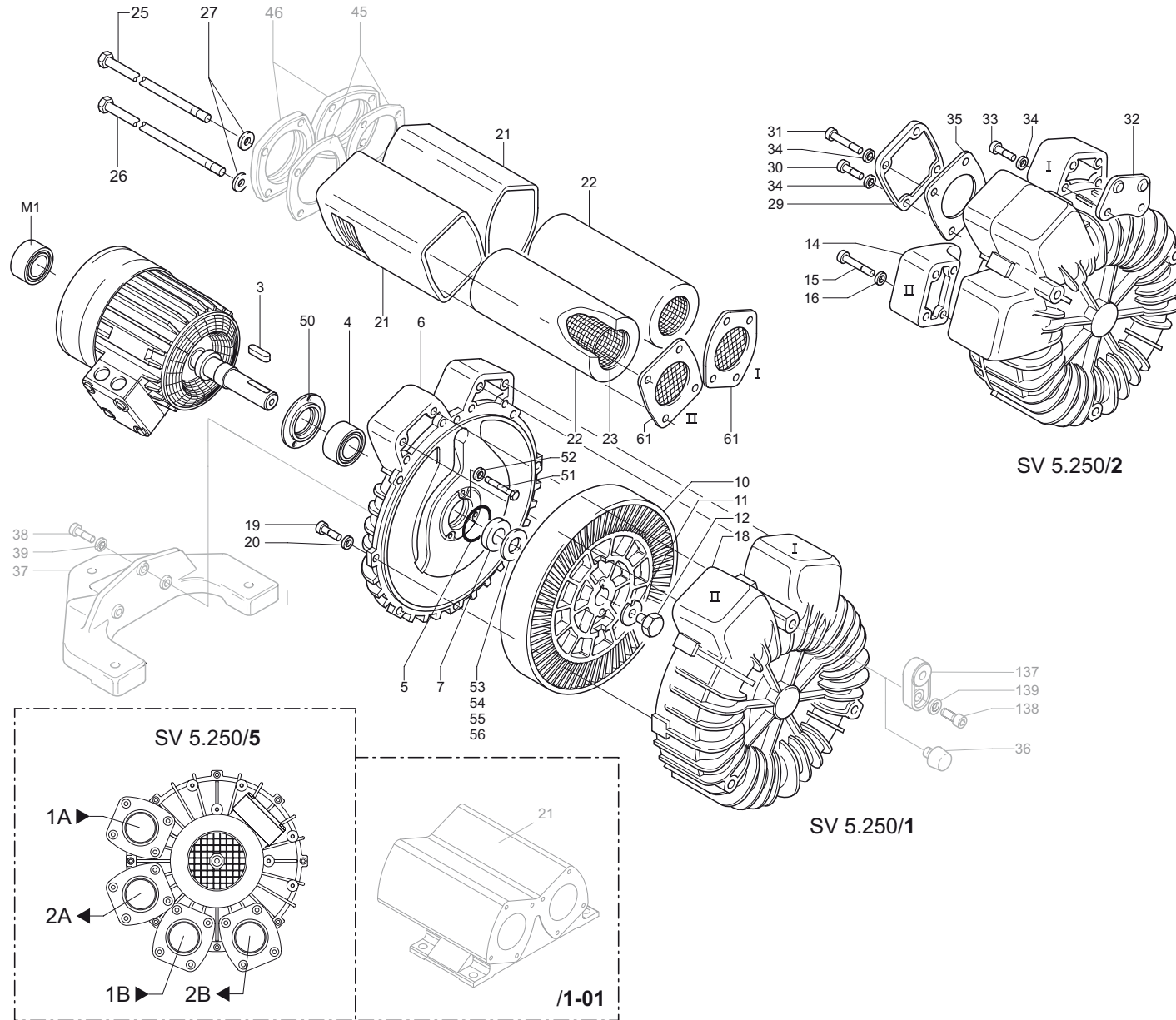

SERVICE ?

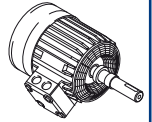

C = ? µF  
U = ? V

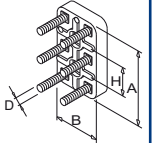
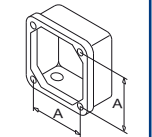
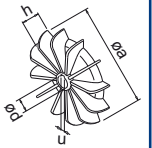
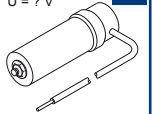

INDEX	Pos.	Bestell Nr.	Beschreibung	
SV 5.250	3	947736 00000	PASSFEDER	
	4	906612 10000	WÄLZLAGER 3206/ 2RS C3 TA <sup>1)</sup>	
	5	911310 00000	DICHTUNGSSCHLAUCH	
	6	000102 92000	GEHÄUSE	
	7	013904 92000	DISTANZBUCHSE	
	10	000600 14400	LAUFRAD	
	11	001900 23000	SICHERUNGSBLECH	
	12	001800 23000	WELLENENDSCHRAUBE	
	14	015500 92000	REDUZIERSTÜCK	
	15	945363 00000	INNENSECHSKANTSCHRAUBE	
	16	951703 00000	FEDERSCHEIBE	
	18	000201 92000	GEHÄUSEDECKEL	
	19	945320 00000	INNENSECHSKANTSCHRAUBE	
	20	951703 00000	FEDERSCHEIBE	
	21	007405 92000	SCHALLDÄMPFERGEHÄUSE	
	22	007700 92000	DÄMPFER (SV5.250/1)	
	22	007701 92000	DÄMPFER (SV5.250/2 + SV5.250/5)	
	23	007600 92000	SIEBROHR (SV5.250/1)	
	23	007601 92000	SIEBROHR (SV5.250/2 + SV5.250/5)	
	25	003801 79000	ZUGANKERSCHRAUBE	
26	903802 01000	ZUGANKERSCHRAUBE		
27	951703 00000	FEDERSCHEIBE		
29	005600 92000	VERSCHLUSSDECKEL		
30	945320 00000	INNENSECHSKANTSCHRAUBE		
31	945364 00000	INNENSECHSKANTSCHRAUBE		
32	005601 92000	VERSCHLUSSDECKEL		
33	945319 00000	INNENSECHSKANTSCHRAUBE		
34	951703 00000	FEDERSCHEIBE		
35	607500 92000	DICHTUNG		
36	741315 00000	GUMMIPUFFER		
37	015100 92000	GERÄTEFUSS		
38	945321 00000	INNENSECHSKANTSCHRAUBE		
39	951703 00000	FEDERSCHEIBE		
45	607500 92000	DICHTUNG		
46	007800 92000	ANSCHLUSSFLANSCH		
50	001101 83000	LAGERDECKEL		
51	945309 00000	INNENSECHSKANTSCHRAUBE		
52	951704 00000	FEDERSCHEIBE		
53	911464 00000	DISTANZSCHEIBE 24X45X0,025		
54	911465 00000	DISTANZSCHEIBE 24X45X0,05		
55	911466 00000	DISTANZSCHEIBE 24X45X0,1		
56	911467 00000	DISTANZSCHEIBE 24X45X0,2		
61	607500 92000	DICHTUNG		
137	015101 79000	GERÄTEFUSS		
138	945320 00000	INNENSECHSKANTSCHRAUBE		
139	951703 00000	FEDERSCHEIBE		
M1	906640 00000	MOTORLAGER 6204 LLUA <sup>1)</sup>		

<sup>1)</sup> Lager sind mit Spezialfett gefüllt. Nur durch Original der Firma Gebr. Becker ersetzen.

INDEX	Pos.	Ident No.	Description	
SV 5.250	3	947736 00000	KEY	
	4	906612 10000	BALL BEARING 3206/ 2RS C3 TA <sup>1)</sup>	
	5	911310 00000	SEAL	
	6	000102 92000	PUMP BODY	
	7	013904 92000	SPACER	
	10	000600 14400	IMPELLER	
	11	001900 23000	LOCKING PLATE	
	12	001800 23000	SCREW	
	14	015500 92000	REDUCING PIECE	
	15	945363 00000	SOCKET HEAD SCREW	
	16	951703 00000	LOCKING WASHER	
	18	000201 92000	HOUSING LID	
	19	945320 00000	SOCKET HEAD SCREW	
	20	951703 00000	LOCKING WASHER	
	21	007405 92000	SILENCER HOUSING	
	22	007700 92000	SILENCER SPONGE (SV5.250/1)	
	22	007701 92000	SILENCER SPONGE (SV5.250/2 + SV5.250/5)	
	23	007600 92000	STRAINER TUBE (SV5.250/1)	
	23	007601 92000	STRAINER TUBE (SV5.250/2 + SV5.250/5)	
	25	003801 79000	SCREW	
26	903802 01000	SCREW		
27	951703 00000	LOCKING WASHER		
29	005600 92000	CAP		
30	945320 00000	SOCKET HEAD SCREW		
31	945364 00000	SOCKET HEAD SCREW		
32	005601 92000	CAP		
33	945319 00000	SOCKET HEAD SCREW		
34	951703 00000	LOCKING WASHER		
35	607500 92000	GASKET		
36	741315 00000	RUBBER BUFFER		
37	015100 92000	FOOT		
38	945321 00000	SOCKET HEAD SCREW		
39	951703 00000	LOCKING WASHER		
45	607500 92000	GASKET		
46	007800 92000	SCREWED FLANGE		
50	001101 83000	BEARING COVER		
51	945309 00000	SOCKET HEAD SCREW		
52	951704 00000	SPRING DISC		
53	911464 00000	DISTANCE DISC 24X45X0,025		
54	911465 00000	DISTANCE DISC 24X45X0,05		
55	911466 00000	DISTANCE DISC 24X45X0,1		
56	911467 00000	DISTANCE DISC 24X45X0,2		
61	607500 92000	GASKET		
137	015101 79000	FOOT		
138	945320 00000	SOCKET HEAD SCREW		
139	951703 00000	LOCKING WASHER		
M1	906640 00000	BEARING 6204 LLUA <sup>1)</sup>		

<sup>1)</sup> Bearings are filled with special grease. Only be replaced by Gebrüder Beckers original.

INDEX	Pos.	No. Identification	Designation	FR	
SV 5.250	3	947736 00000	CLAVETTE		
	4	906612 10000	ROULEMENT A BILLES 3206/ 2RS C3 TA <sup>1)</sup>		
	5	911310 00000	JOINT		
	6	000102 92000	CORP DE POMPE		
	7	013904 92000	DOUILLE		
	10	000600 14400	ROUE		
	11	001900 23000	RONDELLE DE SECURITE		
	12	001800 23000	VIS		
	14	015500 92000	PIECE DE REDUCTION		
	15	945363 00000	VIS HEXAGONALE INTERNE		
	16	951703 00000	RONDELLE À RESSORT		
	18	000201 92000	COUVERCLE		
	19	945320 00000	VIS HEXAGONALE INTERNE		
	20	951703 00000	RONDELLE À RESSORT		
	21	007405 92000	CARCASSE SILENCIEUX		
	22	007700 92000	MOUSSE POUR SILENCIEUX (SV5.250/1)		
	22	007701 92000	MOUSSE POUR SILENCIEUX (SV5.250/2 + SV5.250/5)		
	23	007600 92000	GRILLE POUR SILENCIEUX (SV5.250/1)		
	23	007601 92000	GRILLE POUR SILENCIEUX (SV5.250/2 + SV5.250/5)		
	25	003801 79000	VIS		
26	903802 01000	VIS			
27	951703 00000	RONDELLE À RESSORT			
29	005600 92000	COUVERCLE			
30	945320 00000	VIS HEXAGONALE INTERNE			
31	945364 00000	VIS HEXAGONALE INTERNE			
32	005601 92000	COUVERCLE			
33	945319 00000	VIS HEXAGONALE INTERNE			
34	951703 00000	RONDELLE À RESSORT			
35	607500 92000	JOINT			
36	741315 00000	AMORTISSEUR EN CAOUTCHOUC			
37	015100 92000	PIED			
38	945321 00000	VIS HEXAGONALE INTERNE			
39	951703 00000	RONDELLE À RESSORT			
45	607500 92000	JOINT			
46	007800 92000	BRIDE FILETEE			
50	001101 83000	COUVERCLE DE ROULEMENT			
51	945309 00000	VIS HEXAGONALE INTERNE			
52	951704 00000	DISQUE DE RESSORT			
53	911464 00000	DISQUE AJUSTAGE 24X45X0,025			
54	911465 00000	DISQUE AJUSTAGE 24X45X0,05			
55	911466 00000	DISQUE AJUSTAGE 24X45X0,1			
56	911467 00000	DISQUE AJUSTAGE 24X45X0,2			
61	607500 92000	JOINT			
137	015101 79000	PIED			
138	945320 00000	VIS HEXAGONALE INTERNE			
139	951703 00000	RONDELLE À RESSORT			
M1	906640 00000	ROULEMENT A BILLES 6204 LLUA <sup>1)</sup>			







<sup>1)</sup> Les roulements sont remplis d'une graisse spéciale. N'utiliser que de la graisse d'origine de Gebrüder Becker pour la remplacer

INDEX	Pos.	No. Identificazione	Designazione	IT	
SV 5.250	3	947736 00000	CHIAVETTA		
	4	906612 10000	CUSCINETTO A SFERA 3206/ 2RS C3 TA <sup>1)</sup>		
	5	911310 00000	GUARNIZIONE		
	6	000102 92000	CARCASSA		
	7	013904 92000	BOCCOLA		
	10	000600 14400	GIRANTE		
	11	001900 23000	RONDELLA DI SICUREZZA		
	12	001800 23000	VITE		
	14	015500 92000	GIUNTO DI RIDUZIONE		
	15	945363 00000	VITE ESAGONALE INTERNA		
	16	951703 00000	DISCO A MOLLA		
	18	000201 92000	COPERCHIO		
	19	945320 00000	VITE ESAGONALE INTERNA		
	20	951703 00000	DISCO A MOLLA		
	21	007405 92000	CARCASSA SILENZIATORE		
	22	007700 92000	MATERIALE PER SILENZIATORE (SV5.250/1)		
	22	007701 92000	MATERIALE PER SILENZIATORE (SV5.250/2 + SV5.250/5)		
	23	007600 92000	TUBO-CRIVELLO (SV5.250/1)		
	23	007601 92000	TUBO-CRIVELLO (SV5.250/2 + SV5.250/5)		
	25	003801 79000	VITE		
26	903802 01000	VITE			
27	951703 00000	DISCO A MOLLA			
29	005600 92000	COPERCHIO			
30	945320 00000	VITE ESAGONALE INTERNA			
31	945364 00000	VITE ESAGONALE INTERNA			
32	005601 92000	COPERCHIO			
33	945319 00000	VITE ESAGONALE INTERNA			
34	951703 00000	DISCO A MOLLA			
35	607500 92000	GUARNIZIONE			
36	741315 00000	AMMORTIZZATORE IN GOMMA			
37	015100 92000	PIASTRA DI APPOGGIO			
38	945321 00000	VITE ESAGONALE INTERNA			
39	951703 00000	DISCO A MOLLA			
45	607500 92000	GUARNIZIONE			
46	007800 92000	FLANGIA FILETTATA			
50	001101 83000	COPERCHIO CUSCINETTO			
51	945309 00000	VITE ESAGONALE INTERNA			
52	951704 00000	DISCO A MOLLA			
53	911464 00000	DISCO GIUOCO 24X45X0,025			
54	911465 00000	DISCO GIUOCO 24X45X0,05			
55	911466 00000	DISCO GIUOCO 24X45X0,1			
56	911467 00000	DISCO GIUOCO 24X45X0,2			
61	607500 92000	GUARNIZIONE			
137	015101 79000	PIASTRA DI APPOGGIO			
138	945320 00000	VITE ESAGONALE INTERNA			
139	951703 00000	DISCO A MOLLA			
M1	906640 00000	CUSCINETTO A SFERA 6204 LLUA <sup>1)</sup>			

<sup>1)</sup> I cuscinetti sono riempiti di grasso speciale. Eseguire il reingrassaggio solo con grasso originale della Gebrüder Becker.

INDICE	Pos.	No. De pedido	Descripción		
SV 5.250	3	947736 00000	LENGÜETA DE AJUSTE		
	4	906612 10000	COJINETE DE RODAMIENTO 3206/ 2RS C3 TA <sup>1)</sup>		
	5	911310 00000	MANGUERA DE JUNTA		
	6	000102 92000	CARCASA		
	7	013904 92000	CASQUILLO DISTANCIADOR		
	10	000600 14400	RUEDA CORREDERA		
	11	001900 23000	CHAPA DE ASEGURAMIENTO		
	12	001800 23000	TORNILLO TERMINAL DE ÁRBOL		
	14	015500 92000	PIEZA DE REDUCCIÓN		
	15	945363 00000	TORNILLO HEXAGONAL INTERIOR		
	16	951703 00000	ARANDELA ELÁSTICA		
	18	000201 92000	TAPA DE CARCASA		
	19	945320 00000	TORNILLO HEXAGONAL INTERIOR		
	20	951703 00000	ARANDELA ELÁSTICA		
	21	007405 92000	CARCASA DE SILENCIADOR		
	22	007700 92000	AMORTIGUADOR (SV5.250/1)		
	22	007701 92000	AMORTIGUADOR (SV5.250/2 + SV5.250/5)		
	23	007600 92000	TUBO DE CRIBA (SV5.250/1)		
	23	007601 92000	TUBO DE CRIBA (SV5.250/2 + SV5.250/5)		
	25	003801 79000	TORNILLO TIRANTE		
	26	903802 01000	TORNILLO TIRANTE		
	27	951703 00000	ARANDELA ELÁSTICA		
	29	005600 92000	TAPA DE CIERRE		
	30	945320 00000	TORNILLO HEXAGONAL INTERIOR		
	31	945364 00000	TORNILLO HEXAGONAL INTERIOR		
	32	005601 92000	TAPA DE CIERRE		
	33	945319 00000	TORNILLO HEXAGONAL INTERIOR		
	34	951703 00000	ARANDELA ELÁSTICA		
	35	607500 92000	JUNTA		
	36	741315 00000	AMORTIGUADOR DE GOMA		
	37	015100 92000	PIE DE APARATO		
	38	945321 00000	TORNILLO HEXAGONAL INTERIOR		
	39	951703 00000	ARANDELA ELÁSTICA		
	45	607500 92000	JUNTA		
	46	007800 92000	BRIDA ROSCADA		
	50	001101 83000	TAPA DE COJINETE		
	51	945309 00000	TORNILLO HEXAGONAL INTERIOR		
	52	951704 00000	ARANDELA ELÁSTICA		
	53	911464 00000	ARANDELA DISTANCIADORA 24X45X0,025		
	54	911465 00000	ARANDELA DISTANCIADORA 24X45X0,05		
	55	911466 00000	ARANDELA DISTANCIADORA 24X45X0,1		
56	911467 00000	ARANDELA DISTANCIADORA 24X45X0,2			
61	607500 92000	JUNTA			
137	015101 79000	PIE DE APARATO			
138	945320 00000	TORNILLO HEXAGONAL INTERIOR			
139	951703 00000	ARANDELA ELÁSTICA			
M1	906640 00000	COJINETE DE RODAMIENTO 6204 LLUA <sup>1)</sup>			

<sup>1)</sup> Los rodamientos estan rellenos de grasa especial. Sólo reemplazar por grasa original de Gebrüder Becker

SV5.250/1-XX SV5.250/2-XX	Variante 	Pos. <sup>2)</sup>	Bestell Nr. / Ident No. / No. Identification / No. Identificazione / No. De pedido		Beschreibung / Description / Designation / Designazione / Desripcion
			  	  	
① /1-01 mit Schalldämpferfuß with foot / silencer combination avec combinaison pied / silencieux con combinazione piede / silenziatore con combinación pie / silenciador		21	007406 92000	007405 92000	SCHALLDÄMPFERGEHÄUSE / SILENCER HOUSING / CARCASSE SILENCIEUX / CARCASSA SILENZIATORE / CARCASA DE SILENCIADOR
② /1-05 Korrosionsschutz corrosion protection protection contre la corrosion protezione anti-corrosione protección contra la corrosión		6	000112 92000	000102 92000	GEHÄUSE / PUMP BODY / CORP DE POMPE / CARCASSA / CARCASA
		10	000610 14400	000600 14400	LAUFRAD / IMPELLER / ROUE / GIRANTE / RUEDA CORREDERA
		11	001910 23000	001900 23000	SICHERUNGSBLECH / LOCKING PLATE / RONDELLE DE SECURITE / RONDELLA DI SICUREZZA / CHAPA DE ASEGURAMIENTO
		12	001810 23000	001800 23000	WELLENENDSCHRAUBE / SHAFT END BOLD / VIS BOUT D'ARBRE / VITE DI CHIUSURA ALBERO / TORNILLO TERMINAL DE ÁRBOL
		18	000211 92000	000201 92000	GEHÄUSEDECKEL / HOUSING LID / COUVERCLE / COPERCHIO / TAPA DE CARCASA
		21	007415 92000	007405 92000	SCHALLDÄMPFERGEHÄUSE / SILENCER HOUSING / CARCASSE SILENCIEUX / CARCASSA SILENZIATORE / CARCASA DE SILENCIADOR
③ /2-10 mit Sonderschalldämpfer with special silencer avec silencieux spéciale con silenziatore speciale con silenciador especial		21	007407 92000	007405 92000	SCHALLDÄMPFERGEHÄUSE (1x) / SILENCER HOUSING / CARCASSE SILENCIEUX / CARCASSA SILENZIATORE / CARCASA DE SILENCIADOR

<sup>2)</sup> variantenabhängige Bauteile / variant-dependent components / composants variante-dependantes / componenti variante-dispendenti / componentes variante-dependientes