

KVT 3.100

Ersatzteilliste
 Spare parts list
 Liste de pièces de rechange
 Listino pezzi di ricambio
 Lista de piezas de recambio
 Reservaonderdelenlijst
 Reservdelisliste
 Reservdelislista

Reservdelisliste
 Varaosaluettelo
 Wykaz części zamiennych
 Seznam náhradních dílů
 Tartalékalkatrész lista
 Κατάλογος ανταλλακτικών
 Перечень запасных частей
 备用零件目录
 スペアパーツリスト

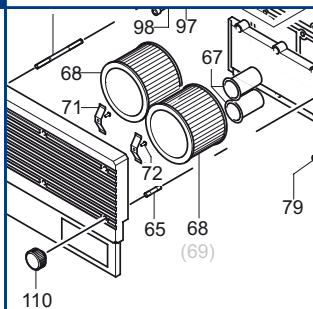

SERVICE

BECKER
D-42279 Wuppertal
www.becker-international.com

year XXXX

No. **D** ← **Index Variante**

type **KVT 3.100-XX**

frequency XXXX Hz

speed XXXX min⁻¹

power required XXXX kW

inlet capacity XXXX m³/h

pressure + XXXX mbar

vacuum - XXXX mbar

Made in Germany

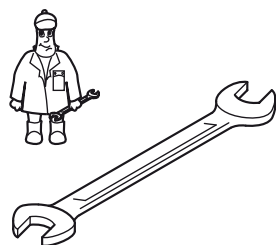

Pos.	Menge ²⁾ Quantity Quantité Quantità Cantidad	Bestell-Nr. Ident No. No. Identification No. Identificazione No. de pedido	Bezeichnung Description Designation Designazione Descripción
□	1	549000 21300	Dichtungssatz, Complete set of seals, Jeu de joints, Kit di guarnizioni, Junta Completa
11 11	SATZ/KIT	901333 00004 901380 00004	Schieber, Rotor Vane, Palette, Empujador " KVT 3.100/6
68	2	909507 00000	Filterpatrone, Filter cartridge, Cartouche Filtrante, Cartuccia filtro, Cartucho de filtro
68	1	909507 00000	" KVT 3.100/6
69	1	909587 00000	" KVT 3.100/6 - Polyester
91	1	909514 00000	Filterpatrone, Filter cartridge, Cartouche Filtrante, Cartuccia filtro, Cartucho de filtro

²⁾ erforderliche Bestellmenge / necessary order quantity / quantité nécessaire / quantità di ordinazione necessari / cantidad necesario

Wartung
Maintenance
Entretien
Manutenzione
Mantenimiento



SERVICE

www.becker-international.com

Sales and service network

KVT 3.100 Standard



Variante



KVT 3.100/XX

①

US-motor

②-⑤

- /6, /6-50, /6-53, /6-66
- Korrosionsschutz
- corrosion protection
- protection contre la corrosion
- protezione anti-corrosione
- protección contra la corrosión

⑥

/0-54

- Kühlung
- refrigeration
- réfrigération
- refrigerazione
- refrigeración

⑦

/0-400

- mit Frequenzumrichter
- with frequency convertor
- avec convertisseur de fréquence
- con convertitore di frequenza
- con convertidor de frecuencia

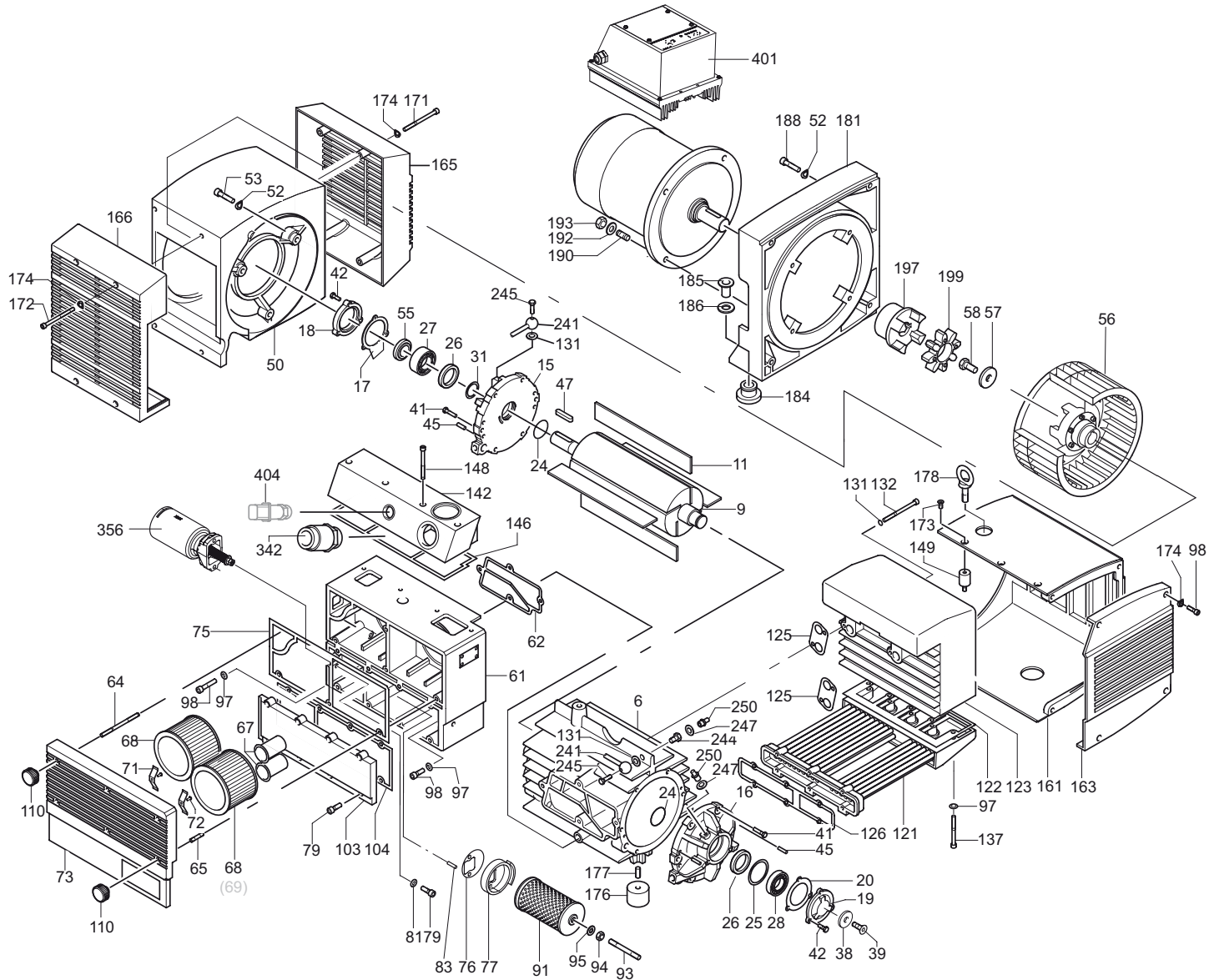

SERVICE ?

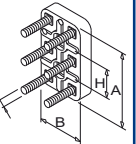
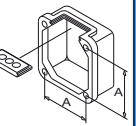
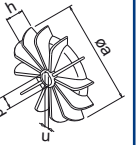
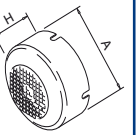
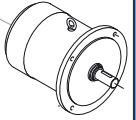



D INDEX	Pos.	Bestell Nr.	Beschreibung	DE
				FR
KVT 3.100	□	549000 21300	DICHTUNGSSATZ ¹⁾	
	6	000101 21200	GEHÄUSE	
	9	020005 21200	KOLBEN	
	11	901333 00004	SCHIEBER (SATZ) ²⁾	
	15	000803 21200	SEITENDECKEL LINKS	
	16	000701 21200	SEITENDECKEL RECHTS	
	17	025512 21200	DICHTUNG	
	18	001100 21200	LAGERDECKEL	
	19	001000 21200	LAGERDECKEL	
	20	025513 21200	DICHTUNG	
	24	911312 00000	DICHTUNGSSCHLAUCH	
	25	917152 00000	AUSGLEICHSCHIEBE	
	26	906540 00000	WELLENDICHRING	
27	906620 00000	WÄLZLAGER 3205/C3		
28	906657 00000	WÄLZLAGER NU 205/ZS		
31	511400 10100	SATZ DISTANZSCHEIBEN		
38	016801 21100	SPANNSCHEIBE		
39	949807 00000	SENKSCHEIBE		
41	945224 00000	SECHSKANTSCHRAUBE		
42	945222 00000	SECHSKANTSCHRAUBE		
45	948742 00000	PASSKERBSTIFT		
47	947736 00000	PASSFEDER		
50	053201 21300	LATERNE		
52	950308 00000	UNTERLEGSCHEIBE		
53	945331 00000	INNENSECHSKANTSCHRAUBE		
55	011400 21200	DISTANZSCHEIBE		
56	544500 21200	KUPPLUNGSHÄLFTE MIT VENTILATOR		
57	949409 00000	UNTERLEGSCHEIBE		
58	945270 00000	WELLENENDSCHRAUBE		
61	040102 21300	FILTERGEHÄUSE		
62	025501 21300	DICHTUNG		
64	951009 00000	STIFTSCHRAUBE		
65	951003 00000	STIFTSCHRAUBE		
67	964407 00000	SCHALLDÄMPFERROHR		
68	909507 00000	FILTERPATRONE C 1112/2 (2x) ²⁾		
71	009000 27000	ANPRESSFEDER		
72	948750 00000	BLINDNIET		
73	040204 21300	FILTERDECKEL		
75	025518 21300	DICHTUNG		
76	025516 21100	DICHTUNG		
77	022802 21100	FILTERTRÄGER		
79	945320 00000	INNENSECHSKANTSCHRAUBE		
81	947504 00000	UNTERLEGSCHEIBE		
83	952019 00000	SPANNHÜLSE		
91	909514 00000	FILTERPATRONE C 718 (1x) ²⁾		
93	903800 70000	STIFTSCHRAUBE		
94	947105 00000	SECHSKANTMUTTER		
95	949450 00000	UNTERLEGSCHEIBE		
97	950304 00000	UNTERLEGSCHEIBE		
98	945321 00000	INNENSECHSKANTSCHRAUBE		
103	068801 21300	STAUBABSCHIEDERDECKEL		
104	025515 21300	DICHTUNG		
110	921500 50000	HANDGRIFF		
121	560204 21300	KÜHLER		
122	025506 21300	DICHTUNG		
123	066802 21300	DRUCKANSCHLUSSKASTEN		
125	025504 21300	DICHTUNG		
126	025514 21300	DICHTUNG		
131	948021 00000	DICHTRING		

D INDEX	Pos.	Bestell Nr.	Beschreibung	DE
				FR
	132	945374 00000	INNENSECHSKANTSCHRAUBE	
	137	945322 00000	INNENSECHSKANTSCHRAUBE	
	142	016605 21300	ANSCHLUSSLEISTE	
	146	025507 21300	DICHTUNG	
	148	945364 00000	INNENSECHSKANTSCHRAUBE	
	149	741310 30000	GUMMIPUFFER	
	161	918300 21300	ABDECKHAUBE	
	163	920800 21300	LUFTLEITHAUBE	
	165	960700 21300	LÜFTERHAUBE	
	166	960701 21300	LÜFTERHAUBE	
	171	945371 00000	INNENSECHSKANTSCHRAUBE	
	172	945372 00000	INNENSECHSKANTSCHRAUBE	
	173	949806 00000	SENKSCHEIBE	
	174	951703 00000	FEDERSCHIEBE	
	176	741302 00000	GUMMIPUFFER	
	177	945634 00000	GEWINDESTIFT	
	178	948802 00000	RINGSCHRAUBE	
	181	014902 21300	ZWISCHENFLANSCH	
	184	951916 00000	KABELTÜLLE	
	185	948772 00000	ROHRNIETE	
	186	947508 00000	UNTERLEGSCHEIBE	
	188	945335 00000	INNENSECHSKANTSCHRAUBE	
	190	951018 00000	STIFTSCHRAUBE	
	192	947506 00000	UNTERLEGSCHEIBE	
	193	947106 00000	SECHSKANTMUTTER	
	197	902108 00000	KUPPLUNGSHÄLFTE (MOT)	
	199	902210 00000	KUPPLUNGSSCHIEBE	
	241	012200 21200	LEITUNG	
	244	912300 00000	ANSCHLUSSSCHRAUBE	
	245	009400 19000	KUGELSTÜCKSCHRAUBE	
	247	948074 00000	DICHTRING	
	250	949002 00000	TRICHTERSCHMIERNIPPEL	
	342	736001 99624	VAKUUMREGULIERVENTIL	
	356	727510 99323	ABBLASEVENTIL	
		743303 00000	LAGERFETT, AMBLYGON TA15/2 (FETTPRESSE, 50g)	

¹⁾ Dichtungssatz - 54900021300 - Pos.: 17, 20, 24, 62, 75, 76, 86, 104, 122, 125, 126, 146

²⁾ erforderliche Bestellmenge / Wartung

D INDEX	Pos.	Ident No.	Description	
KVT 3.100	□	549000 21300	SET OF SEALS ¹⁾	
	6	000101 21200	PUMP BODY	
	9	020005 21200	ROTOR	
	11	901333 00004	CARBON VANES (KIT) ²⁾	
	15	000803 21200	LID -LEFT	
	16	000701 21200	LID RIGHT	
	17	025512 21200	GASKET	
	18	001100 21200	BEARING COVER	
	19	001000 21200	BEARING COVER	
	20	025513 21200	GASKET	
	24	911312 00000	SEAL	
	25	917152 00000	COMPENSATING DISC	
	26	906540 00000	SHAFT-SEALING RING	
27	906620 00000	BALL BEARING		
28	906657 00000	BALL BEARING		
31	511400 10100	SET DISTANCE DISC		
38	016801 21100	CLAMPING DISC		
39	949807 00000	SCREW		
41	945224 00000	HEX-HEAD SCREW		
42	945222 00000	HEX-HEAD SCREW		
45	948742 00000	STRAIGHT PIN		
47	947736 00000	KEY		
50	053201 21300	CONNECTION FLANGE		
52	950308 00000	WASHER		
53	945331 00000	SOCKET HEAD SCREW		
55	011400 21200	DISTANCE DISC		
56	544500 21200	COUPLING WITH FAN		
57	949409 00000	WASHER		
58	945270 00000	SHAFT END BOLD		
61	040102 21300	FILTER HOUSING		
62	025501 21300	GASKET		
64	951009 00000	STUD		
65	951003 00000	STUD		
67	964407 00000	SILENCER TUBE		
68	909507 00000	FILTER CARTRIDGE C 1112/2 (2x) ²⁾		
71	009000 27000	LEAF SPRING		
72	948750 00000	BLIND RIVET		
73	040204 21300	FILTER COVER		
75	025518 21300	GASKET		
76	025516 21100	GASKET		
77	022802 21100	FILTER HOLDER		
79	945320 00000	SOCKET HEAD SCREW		
81	947504 00000	WASHER		
83	952019 00000	LOCATING PEG		
91	909514 00000	FILTER CARTRIDGE C 718 (1x) ²⁾		
93	903800 70000	STUD		
94	947105 00000	HEX.NUT		
95	949450 00000	WASHER		
97	950304 00000	WASHER		
98	945321 00000	SOCKET HEAD SCREW		
103	068801 21300	DUST SEPARATOR COVER		
104	025515 21300	GASKET		
110	921500 50000	HANDLE		
121	560204 21300	COOLER		
122	025506 21300	GASKET		
123	066802 21300	PRESSURE CONNECTION BOX		
125	025504 21300	GASKET		
126	025514 21300	GASKET		
131	948021 00000	SEALING RING		

D INDEX	Pos.	Ident No.	Description	
	132	945374 00000	SOCKET HEAD SCREW	
	137	945322 00000	SOCKET HEAD SCREW	
	142	016605 21300	CONNECTING PIECE	
	146	025507 21300	GASKET	
	148	945364 00000	SOCKET HEAD SCREW	
	149	741310 30000	RUBBER BUFFER	
	161	918300 21300	COVERING HOOD	
	163	920800 21300	AIR GUIDE HOOD	
	165	960700 21300	VENTILATOR HOOD	
	166	960701 21300	VENTILATOR HOOD	
	171	945371 00000	SOCKET HEAD SCREW	
	172	945372 00000	SOCKET HEAD SCREW	
	173	949806 00000	SCREW	
	174	951703 00000	SPRING DISC	
	176	741302 00000	RUBBER BUFFER	
	177	945634 00000	THREADED PIN	
	178	948802 00000	RING SCREW	
	181	014902 21300	FLANGE	
	184	951916 00000	RUBBER BUSHING	
	185	948772 00000	PIPE RIVET	
	186	947508 00000	WASHER	
	188	945335 00000	SOCKET HEAD SCREW	
	190	951018 00000	STUD	
	192	947506 00000	WASHER	
	193	947106 00000	HEX.NUT	
	197	902108 00000	COUPLING	
	199	902210 00000	COUPLING DISC	
	241	012200 21200	OIL-PIPE	
	244	912300 00000	CONNECTING SCREW	
	245	009400 19000	HOLLOW HOLDING SCREW	
	247	948074 00000	SEALING RING	
	250	949002 00000	GREASE NIPPLE	
	342	736001 99624	VACUUM REGULATING VALVE	
	356	727510 99323	BLOW-OFF VALVE	
		743303 00000	GREASE, AMBLYGON TA15/2 (GREASE PRESS, 50g)	

¹⁾ Set of seals - 54900021300 - Pos.: 17, 20, 24, 62, 75, 76, 86, 104, 122, 125, 126, 146
²⁾ necessary order quantity / maintenance

D INDICE	Pos.	No. Identification	Designation	FR	
KVT 3.100	□	549000 21300	JEU DE JOINTS ¹⁾		
	6	000101 21200	CORP DE POMPE		
	9	020005 21200	PISTON		
	11	901333 00004	PALETTE DE CHARBON (KIT) ²⁾		
	15	000803 21200	COUVERCLE A GAUCHE		
	16	000701 21200	COUVERCLE A DROITE		
	17	025512 21200	JOINT		
	18	001100 21200	COUVERCLE DE ROULEMENTE		
	19	001000 21200	COUVERCLE DE ROULEMENTE		
	20	025513 21200	JOINT		
	24	911312 00000	JOINT		
	25	917152 00000	DISQUE DE COMPENSATION		
	26	906540 00000	BAGUE D'ETANCHEITE P.L'AXE		
27	906620 00000	ROULEMENT A BILLES			
28	906657 00000	ROULEMENT A BILLES			
31	511400 10100	JEU DISQUE DE TOLERANCE			
38	016801 21100	DISQUE DE SERRAGE			
39	949807 00000	VIS			
41	945224 00000	VIS HEXAGONALE			
42	945222 00000	VIS HEXAGONALE			
45	948742 00000	GOUPILLE CYLINDRIQUE			
47	947736 00000	CLAVETTE			
50	053201 21300	BRIDE DE RACCORDEMENT			
52	950308 00000	RONDELLE			
53	945331 00000	VIS HEXAGONALE INTERNE			
55	011400 21200	DISQUE AJUSTAGE			
56	544500 21200	ACCOUPLLEMENT AVEC VENTILATEUR			
57	949409 00000	RONDELLE			
58	945270 00000	VIS BOUT D'ARBRE			
61	040102 21300	BOITE POUR FILTRE			
62	025501 21300	JOINT			
64	951009 00000	PRISONNIER			
65	951003 00000	PRISONNIER			
67	964407 00000	TUBE SILENCIEUX			
68	909507 00000	CARTOUCHE FILTRANTE C 1112/2 (2x) ²⁾			
71	009000 27000	RESSORT-JAME			
72	948750 00000	RIVET AVEUGLIE			
73	040204 21300	COUVERCLE DE FILTRE			
75	025518 21300	JOINT			
76	025516 21100	JOINT			
77	022802 21100	SUPPORT FILTRE			
79	945320 00000	VIS HEXAGONALE INTERNE			
81	947504 00000	RONDELLE			
83	952019 00000	DOUILLE DE ETRAGE			
91	909514 00000	CARTOUCHE FILTRANTE C 718 (1x) ²⁾			
93	903800 70000	PRISONNIER			
94	947105 00000	ECROU A 6 PANS			
95	949450 00000	RONDELLE			
97	950304 00000	RONDELLE			
98	945321 00000	VIS HEXAGONALE INTERNE			
103	068801 21300	COUVERCLE			
104	025515 21300	JOINT			
110	921500 50000	POIGNEE			
121	560204 21300	REFROIDISSEUR			
122	025506 21300	JOINT			
123	066802 21300	BOITIER DE RACCORD DE REFOULEMENT			
125	025504 21300	JOINT			
126	025514 21300	JOINT			
131	948021 00000	JOINT			

D INDICE	Pos.	No. Identification	Designation	FR	
	132	945374 00000	VIS HEXAGONALE INTERNE		
	137	945322 00000	VIS HEXAGONALE INTERNE		
	142	016605 21300	PIECE RACCORD		
	146	025507 21300	JOINT		
	148	945364 00000	VIS HEXAGONALE INTERNE		
	149	741310 30000	AMORTISSEUR EN CAOUTCHOUC		
	161	918300 21300	CARTER		
	163	920800 21300	CAPOT DE CANALISATION DE L'AIR		
	165	960700 21300	CARTER DE VENTILATEUR		
	166	960701 21300	CARTER DE VENTILATEUR		
	171	945371 00000	VIS HEXAGONALE INTERNE		
	172	945372 00000	VIS HEXAGONALE INTERNE		
	173	949806 00000	VIS A TÊTE NOYÉE		
	174	951703 00000	DISQUE DE RESSORT		
	176	741302 00000	AMORTISSEUR EN CAOUTCHOUC		
	177	945634 00000	GOUPILLE FILETEE		
	178	948802 00000	PITON		
	181	014902 21300	BRIDE		
	184	951916 00000	PROTECTION EN CAOUTCHOUC		
	185	948772 00000	RIVET TUBE		
	186	947508 00000	RONDELLE		
	188	945335 00000	VIS HEXAGONALE INTERNE		
	190	951018 00000	PRISONNIER		
	192	947506 00000	RONDELLE		
	193	947106 00000	ECROU A 6 PANS		
	197	902108 00000	ACCOUPLLEMENT		
	199	902210 00000	DISQUE D'ACCOUPLLEMENT		
	241	012200 21200	TUYEAU DE GRAISSAGE		
	244	912300 00000	VIS DE RACCORD		
	245	009400 19000	VIS CREUSE DE FIXATION		
	247	948074 00000	JOINT		
	250	949002 00000	GRAISSEUR		
	342	736001 99624	SOUPAPE REGULAGE VIDE		
	356	727510 99323	SOUPAPE D'ÉCHAPPEMENT		
		743303 00000	GRAISSE, AMBLYGON TA15/2 (POMPE À GRAISSE, 50g)		
					

¹⁾ Jeu de joints - 54900021300 - Pos.: 17, 20, 24, 62, 75, 76, 86, 104, 122, 125, 126, 146
²⁾ quantité nécessaire / entretien



D INDICE	Pos.	No. Identificazione	Designazione
KVT 3.100	□	549000 21300	SERIE DI GUARNIZIONE ¹⁾
	6	000101 21200	CARCASSA
	9	020005 21200	ROTORE
	11	901333 00004	PALETTE DI CHARBONE (KIT) ²⁾
	15	000803 21200	COPERCHIO SINISTRA
	16	000701 21200	COPERCHIO DESTRA
	17	025512 21200	GUARNIZIONE
	18	001100 21200	COPERCHIO CUSCINETTO
	19	001000 21200	COPERCHIO CUSCINETTO
	20	025513 21200	GUARNIZIONE
	24	911312 00000	GUARNIZIONE
	25	917152 00000	DISCO COMPENSATORE
	26	906540 00000	GUARNIZIONE PER L'ALBERO
	27	906620 00000	CUSCINETTO A SFERA
	28	906657 00000	CUSCINETTO A SFERA
	31	511400 10100	SERIE DISCO GIUOCO
	38	016801 21100	DISCO DI FISSAGGIO
	39	949807 00000	VITE
	41	945224 00000	VITE ESAGONALE
	42	945222 00000	VITE ESAGONALE
	45	948742 00000	PERNO
	47	947736 00000	CHIAVETTA
	50	053201 21300	FLANGIA DI RACCORDE
	52	950308 00000	RONDELLA
	53	945331 00000	VITE ESAGONALE INTERNA
	55	011400 21200	DISCO GIUOCO
	56	544500 21200	GIUNTO CON VENTILATORE
	57	949409 00000	RONDELLA
	58	945270 00000	VITE DI CHIUSURA ALBERO
	61	040102 21300	CONTENITORE FILTRO
	62	025501 21300	GUARNIZIONE
	64	951009 00000	L'ASTA A VITE
	65	951003 00000	L'ASTA A VITE
	67	964407 00000	TUBO SILENZIATORE
	68	909507 00000	CARTUCCIA FILTRO C 1112/2 (2x) ²⁾
	71	009000 27000	MOLLA
	72	948750 00000	RIVETTO CIECO
	73	040204 21300	COPERCHIO FILTRO
	75	025518 21300	GUARNIZIONE
	76	025516 21100	GUARNIZIONE
	77	022802 21100	SUPPORTO FILTRO
	79	945320 00000	VITE ESAGONALE INTERNA
	81	947504 00000	RONDELLA
	83	952019 00000	SPINE DI RISCONTRO
	91	909514 00000	CARTUCCIA FILTRO C 718 (1x) ²⁾
	93	903800 70000	L'ASTA A VITE
	94	947105 00000	DADO ESAGONALE
	95	949450 00000	RONDELLA
	97	950304 00000	RONDELLA
	98	945321 00000	VITE ESAGONALE INTERNA
	103	068801 21300	COPERCHIO
	104	025515 21300	GUARNIZIONI
	110	921500 50000	MANETTA
	121	560204 21300	RAFFREDDATORE
	122	025506 21300	GUARNIZIONE
	123	066802 21300	SCATOLA DI RACCORDO DI MANDATA
	125	025504 21300	GUARNIZIONE
	126	025514 21300	GUARNIZIONI
	131	948021 00000	ANELLO GUARNIZIONE

D INDICE	Pos.	No. Identificazione	Designazione
	132	945374 00000	VITE ESAGONALE INTERNA
	137	945322 00000	VITE ESAGONALE INTERNA
	142	016605 21300	PEZZI RACCORDI
	146	025507 21300	GUARNIZIONE
	148	945364 00000	VITE ESAGONALE INTERNA
	149	741310 30000	AMMORTIZZATORE IN GOMMA
	161	918300 21300	CARTER
	163	920800 21300	CAPPOTTA DEL CONDOTTA ARIA
	165	960700 21300	CARTER VENTILATORE
	166	960701 21300	CARTER VENTILATORE
	171	945371 00000	VITE ESAGONALE INTERNA
	172	945372 00000	VITE ESAGONALE INTERNA
	173	949806 00000	VITE A TESTA SVASATA
	174	951703 00000	DISCO A MOLLA
	176	741302 00000	AMMORTIZZATORE IN GOMMA
	177	945634 00000	SPINA FILETTATURA
	178	948802 00000	GANCIO
	181	014902 21300	FLANGIA
	184	951916 00000	PROTEZIONE IN GOMMA
	185	948772 00000	CHiodo TUBOLARE
	186	947508 00000	RONDELLA
	188	945335 00000	VITE ESAGONALE INTERNA
	190	951018 00000	L'ASTA VITE
	192	947506 00000	RONDELLA
	193	947106 00000	DADO ESAGONALE
	197	902108 00000	GIUNTO
	199	902210 00000	DISCO GUINTO
	241	012200 21200	CONDOTTO
	244	912300 00000	ATTACO FILETTATO
	245	009400 19000	VITE PASSAGGIO OLIO
	247	948074 00000	ANELLO GUARNIZIONE
	250	949002 00000	RACCORDO DI LUBRIFICAZIONE
	342	736001 99624	VALVOLA REGOLAZIONE VUOTO
	356	727510 99323	VALVOLA DI SFIATO
		743303 00000	GRASSO, AMBLYGON TA15/2 (INGRASSATORE A PISTOLA, 50g)

¹⁾ Serie di guarnizione - 54900021300 - Pos.: 17, 20, 24, 62, 75, 76, 86, 104, 122, 125, 126, 146

²⁾ quantità di ordinazione necessari / manutenzione

D INDICE	Pos.	No. De pedido	Descripción	
KVT 3.100	□	549000 21300	JUNTA COMPLETA ¹⁾	
	6	000101 21200	CARCASA	
	9	020005 21200	ÉMBOLO, ACABADO	
	11	901333 00004	EMPUJADOR (KIT) ²⁾	
	15	000803 21200	TAPA LATERAL	
	16	000701 21200	TAPA LATERAL DERECHA	
	17	025512 21200	JUNTA	
	18	001100 21200	TAPA DE COJINETE	
	19	001000 21200	TAPA DE COJINETE	
	20	025513 21200	JUNTA	
	24	911312 00000	MANGUERA DE JUNTA	
	25	917152 00000	ARANDELA DE COMPENSACIÓN	
	26	906540 00000	ANILLO DE JUNTA DE ÁRBOL	
	27	906620 00000	COJINETE DE RODAMIENTO	
	28	906657 00000	COJINETE DE RODAMIENTO NU 205/ZS	
	31	511400 10100	JUEGO DE ARANDELAS DISTANCIADORAS	
	38	016801 21100	ARANDELA TENSORA	
	39	949807 00000	TORNILLO AVELLANADO	
	41	945224 00000	TORNILLO DE CABEZA HEXAGONAL	
	42	945222 00000	TORNILLO DE CABEZA HEXAGONAL	
	45	948742 00000	PASADOR ENTALLADO DE AJUSTE	
	47	947736 00000	LENGÜETA DE AJUSTE	
	50	053201 21300	FAROL	
	52	950308 00000	ARANDELA	
	53	945331 00000	TORNILLO HEXAGONAL INTERIOR	
	55	011400 21200	ARANDELA DISTANCIADORA	
	56	544500 21200	MITAD DE ACOPLAMIENTO CON VENTILADOR	
	57	949409 00000	ARANDELA	
	58	945270 00000	TORNILLO TERMINAL DE ÁRBOL	
	61	040102 21300	CARCASA DE FILTRO	
	62	025501 21300	JUNTA	
	64	951009 00000	ESPÁRRAGO	
	65	951003 00000	ESPÁRRAGO	
	67	964407 00000	TUBO DE SILENCIADOR	
	68	909507 00000	CARTUCHO DE FILTRO C 1112/2 (2x) ²⁾	
	71	009000 27000	MUELLE DE PRESIÓN	
	72	948750 00000	REMACHE CIEGO	
	73	040204 21300	TAPA DE FILTRO	
	75	025518 21300	JUNTA	
	76	025516 21100	JUNTA	
	77	022802 21100	SOPORTE DE FILTRO	
	79	945320 00000	TORNILLO HEXAGONAL INTERIOR	
	81	947504 00000	ARANDELA	
	83	952019 00000	CASQUILLO TENSOR	
	91	909514 00000	CARTUCHO DE FILTRO C 718 (1x) ²⁾	
	93	903800 70000	ESPÁRRAGO	
	94	947105 00000	TUERCA HEXAGONAL	
	95	949450 00000	ARANDELA	
	97	950304 00000	ARANDELA	
	98	945321 00000	TORNILLO HEXAGONAL INTERIOR	
	103	068801 21300	TAPA DE SEPARADOR DE POLVO	
	104	025515 21300	JUNTA	
	110	921500 50000	EMPUÑADURA	
	121	560204 21300	REFRIGERADOR	
	122	025506 21300	JUNTA	
	123	066802 21300	CAJA DE EMPALME DE PRESIÓN	
	125	025504 21300	JUNTA	
	126	025514 21300	JUNTA	
	131	948021 00000	ANILLO DE JUNTA	

D INDICE	Pos.	No. De pedido	Descripción	
	132	945374 00000	TORNILLO HEXAGONAL INTERIOR	
	137	945322 00000	TORNILLO HEXAGONAL INTERIOR	
	142	016605 21300	PIEZA DE EMPALME	
	146	025507 21300	JUNTA	
	148	945364 00000	TORNILLO HEXAGONAL INTERIOR	
	149	741310 30000	AMORTIGUADOR DE GOMA	
	161	918300 21300	CAPERUZA DE RECUBRIMIENTO	
	163	920800 21300	CAPERUZA CONDUCTOR DE AIRE	
	165	960700 21300	CAPERUZA DE VENTILADOR	
	166	960701 21300	CAPERUZA DE VENTILADOR	
	171	945371 00000	TORNILLO HEXAGONAL INTERIOR	
	172	945372 00000	TORNILLO HEXAGONAL INTERIOR	
	173	949806 00000	TORNILLO AVELLANADO	
	174	951703 00000	ARANDELA ELÁSTICA	
	176	741302 00000	AMORTIGUADOR DE GOMA	
	177	945634 00000	VARILLA ROSCADA	
	178	948802 00000	TORNILLO DE CÁNCAMO	
	181	014902 21300	BRIDA INTERMEDIA	
	184	951916 00000	BOQUILLA DE CABLE	
	185	948772 00000	REMACHE TUBULAR	
	186	947508 00000	ARANDELA	
	188	945335 00000	TORNILLO HEXAGONAL INTERIOR	
	190	951018 00000	ESPÁRRAGO	
	192	947506 00000	ARANDELA	
	193	947106 00000	TUERCA HEXAGONAL	
	197	902108 00000	MITAD DE ACOPLAMIENTO (MOT)	
	199	902210 00000	DISCO DE ACOPLAMIENTO	
	241	012200 21200	CONDUCTO	
	244	912300 00000	TORNILLO DE EMPALME	
	245	009400 19000	TORNILLO DE PIEZA ESFÉRICA	
	247	948074 00000	ANILLO DE JUNTA	
	250	949002 00000	BOQUILLA DE TOLVA DE LUBRICACIÓN	
	342	736001 99624	VÁLVULA REGULADORA DE VACÍO	
	356	727510 99323	VÁLVULA DE ESCAPE	
		743303 00000	GRASA, AMBLYGON TA15/2 (PISTOLA DE GRASA, 50g)	
				

¹⁾ Junta completa - 54900021300 - Pos.: 17, 20, 24, 62, 75, 76, 86, 104, 122, 125, 126, 146
²⁾ cantidad necesario / mantenimiento

KVT 3.100	Variante 	Pos. ²⁾	Bestell Nr. / Ident No. / No. Identification / No. Identificazione / No. De pedido		Beschreibung / Description / Designation / Designazione / Desripcion
① US-motor		181		014902-21300	ZWISCHENFLANSCH / FLANGE / BRIDE / FLANGIA / BRIDA INTERMEDIA
		197		902108-00000	KUPPLUNGSHÄLFTE / COUPLING / ACCOUPLEMENT / GIUNTO / MITAD DE ACOPLAMIENTO
		233	014903 21300		(B5 - 300) ZWISCHENFLANSCH / FLANGE / BRIDE / FLANGIA / BRIDA INTERMEDIA
		234	037900 10400		(B5 - 250) ZWISCHENFLANSCH / FLANGE / BRIDE / FLANGIA / BRIDA INTERMEDIA
		235	902100 21100		KUPPLUNGSHÄLFTE / COUPLING / ACCOUPLEMENT / GIUNTO / MITAD DE ACOPLAMIENTO
② /6 - Korrosionsschutz - corrosion protection - protection contre la corrosion - protezione anti-corrosione - protección contra la corrosión		6	000111 21200	000101-21200	GEHÄUSE / PUMP BODY / CORP DE POMPE / CARCASSA / CARCASA
		9	020011 21200	020005-21200	KOLBEN / ROTOR / PISTON / ROTORE / ÉMBOLO
		11	901380 00004	901333-00004	SATZ (KIT) SCHIEBER / VANES / PALETTE / PALETTE / EMPUJADOR
		15	000811 21200	000803-21200	SEITENDECKEL / LID LATERAL / COUVERCLE LATÉRAL / COPERCHIO LATERALE / TAPA LATERAL
		16	000711 21200	000701-21200	SEITENDECKEL / LID LATERAL / COUVERCLE LATÉRAL / COPERCHIO LATERALE / TAPA LATERAL
		68		909507-00000	(1x) FILTERPATRONE / FILTER CARTRIDGE / CARTOUCHE FILTRE / CARTUCCIA FILTRO / CARTUCHO DE FILTRO
	69	909587 00000		(1x POLYESTER) FILTERPATRONE / FILTER CARTRIDGE / CARTOUCHE FILTRE / CARTUCCIA FILTRO / CARTUCHO DE FILTRO	
③+④ /6-50 + /6-53 - Korrosionsschutz - corrosion protection - protection contre la corrosion - protezione anti-corrosione - protección contra la corrosión		3	945217 00000		SECHSKANTSCHRAUBE / HEX-HEAD SCREW / VIS HEXAGONALE / VITE ESAGONALE / TORNILLO DE CABEZA HEXAGONAL
		6	000111 21200	000101-21200	GEHÄUSE / PUMP BODY / CORP DE POMPE / CARCASSA / CARCASA
		9	020011 21200	020005-21200	KOLBEN / ROTOR / PISTON / ROTORE / ÉMBOLO
		11	901380 00004	901333-00004	SATZ (KIT) SCHIEBER / VANES / PALETTE / PALETTE / EMPUJADOR
		15	000811 21200	000803-21200	SEITENDECKEL / LID LATERAL / COUVERCLE LATÉRAL / COPERCHIO LATERALE / TAPA LATERAL
		16	000711 21200	000701-21200	SEITENDECKEL / LID LATERAL / COUVERCLE LATÉRAL / COPERCHIO LATERALE / TAPA LATERAL
		17		025512-21200	DICHTUNG / GASKET / JOINT / GUARNIZIONE / JUNTA
		19	001000 21100	001000-21200	LAGERDECKEL / BEARING COVER / COUVERCLE DE ROULEMENTE / COPERCHIO CUSCINETTO / TAPA DE COJINETE
		20	025511 21100	025513-21200	DICHTUNG / GASKET / JOINT / GUARNIZIONE / JUNTA
		27	906612 50000	906620-00000	WÄLZLAGER / BALL BEARING / ROULEMENT A BILLES / CUSCINETTO A SFERA / COJINETE DE RODAMIENTO
		68		909507-00000	(1x) FILTERPATRONE / FILTER CARTRIDGE / CARTOUCHE FILTRE / CARTUCCIA FILTRO / CARTUCHO DE FILTRO
		69	909587 00000		(1x POLYESTER) FILTERPATRONE / FILTER CARTRIDGE / CARTOUCHE FILTRE / CARTUCCIA FILTRO / CARTUCHO DE FILTRO
		91		909514-00000	FILTERPATRONE / FILTER CARTRIDGE / CARTOUCHE FILTRE / CARTUCCIA FILTRO / CARTUCHO DE FILTRO
		149	011403 21200	741310-30000	GUMMIPUFFER / RUBBER BUFFER / AMORTISSEUR EN CAOUTCHOUC / AMMORTIZZATORE IN GOMMA / AMORTIGUADOR DE GOMA
		190	915026 00000	951018-00000	STIFTSCHRAUBE / STUD / PRISONNIER / L'ASTA A VITE / ESPÁRRAGO
	204	011402 21200		DISTANZSCHEIBE / DISTANCE DISC / DISQUE AJUSTAGE / DISCO GIUOCO / ARANDELA DISTANCIADORA	
	501	767100 21200		SCHALLSCHUTZHAUBE / SOUND-INSULATING HOOD / CAPOT INSONORISANT / CAPPACUSTICA / CAPA INSONORIZANTE	

²⁾ variantenabhängige Bauteile / variant-dependent components / composants variante-dependantes / componenti variante-dispendenti / componentes variante-dependientes

KVT 3.100	Variante 	Pos. ²⁾	Bestell Nr. / Ident No. / No. Identification / No. Identificazione / No. De pedido		Beschreibung / Description / Designation / Designazione / Desripcion
⑤ /6-66 - Korrosionsschutz - corrosion protection - protection contre la corrosion - protezione anti-corrosione - protección contra la corrosión		6	000111 21200	000101-21200	GEHÄUSE / PUMP BODY / CORP DE POMPE / CARCASSA / CARCASA
		9	020011 21200	020005-21200	KOLBEN / ROTOR / PISTON / ROTORE / ÉMBOLO
		11	901380 00004	901333-00004	SATZ (KIT) SCHIEBER / VANES / PALETTE / PALETTE / EMPUJADOR
		15	000811 21200	000803-21200	SEITENDECKEL / LID LATERAL / COUVERCLE LATÉRAL / COPERCHIO LATERALE / TAPA LATERAL
		16	000711 21200	000701-21200	SEITENDECKEL / LID LATERAL / COUVERCLE LATÉRAL / COPERCHIO LATERALE / TAPA LATERAL
		23	903245 00000		DICHTUNG / GASKET / JOINT / GUARNIZIONE / JUNTA
		61	040104 21300	040102-21300	FILTERGEHÄUSE / FILTER HOUSING / BOITE POUR FILTRE / CONTENITORE FILTRO A CARTUCCIA / CARCASA DE FILTRO
		68		909507-00000	(1x) FILTERPATRONE / FILTER CARTRIDGE / CARTOUCHE FILTRE / CARTUCCIA FILTRO / CARTUCHO DE FILTRO
		69	909587 00000		(1x POLYESTER) FILTERPATRONE / FILTER CARTRIDGE / CARTOUCHE FILTRE / CARTUCCIA FILTRO / CARTUCHO DE FILTRO
		77		022802-21100	FILTERTRÄGER / FILTER HOLDER / SUPPORT FILTRE / SUPPORTO FILTRO / SOPORTE DE FILTRO
		79	945321 00000	945320-00000	SCHRAUBE / SCREW / VIS / VITE / TORNILLO
		91		909514-00000	FILTERPATRONE / FILTER CARTRIDGE / CARTOUCHE FILTRE / CARTUCCIA FILTRO / CARTUCHO DE FILTRO
		93	946107 00000	903800-70000	STIFTSCHRAUBE / STUD / PRISONNIER / L'ASTA A VITE / ESPÁRRAGO
	190	951022 00000	951018-00000	STIFTSCHRAUBE / STUD / PRISONNIER / L'ASTA A VITE / ESPÁRRAGO	
⑥ /0-54 - Kühlung - refrigeration - réfrigération - refrigerazione - refrigeración		80	946944 00000		STIFTSCHRAUBE / STUD / TOURILLON / L'ASTA A VITE / ESPÁRRAGO
		82	947104 00000		SECHSKANTMUTTER / HEX.NUT / ECROU A 6 PANS / DADO ESAGONALE / TUERCA HEXAGONAL
		86	025515 21100		DICHTUNG / GASKET / JOINT / GUARNIZIONE / JUNTA
		141	016604 21300		ANSCHLUSS-STÜCK / CONNECTING PIECE / PIECE RACCORD / PEZZI RACCORDI / PIEZA DE EMPALME
		142		016605-21300	ANSCHLUSS-STÜCK / CONNECTING PIECE / PIECE RACCORD / PEZZI RACCORDI / PIEZA DE EMPALME
	230	019901 21100		UMLLENKSTÜCK / RETURN PIECE / PIECE DE RETOUR / PEZZO INVERSIONE / PIEZA DE DESVIACIÓN	
⑦ /0-400 - mit Frequenzumrichter - with frequency convertor - avec convertisseur de fréquence - con convertitore di frequenza - protección contra la corrosión		61	040103 21300	040102-21300	FILTERGEHÄUSE / FILTER HOUSING / BOITE POUR FILTRE / CONTENITORE FILTRO / CARCASA DE FILTRO
		142	016606 21300	016605-21300	ANSCHLUSSLEISTE / CONNECTING PIECE / PIECE RACCORD / PEZZI RACCORDI / PIEZA DE EMPALME
		401	796302 41115		FREQUENZUMFORMER / FREQUENCY CONVERTOR / CONVERTISSEUR DE FRÉQUENCE / CONVERTITORE DI FREQUENZA / CONVERTIDOR DE FRECUENCIA
		404	769302 42090		MESSUMFORMER / MEASUREMENT CONVERTER / CONVERTISSEUR DE MESURE / CONVERTITORE DI MISURA / CONVERTIDOR DE MEDIDA

²⁾ variantenabhängige Bauteile / variant-dependent components / composants variante-dependantes / componenti variante-dispendenti / componentes variante-dependientes