

Betriebsanleitung
 Operating Instructions
 Instructions de service
 Istruzioni d'uso
 Handleiding
 Instrucciones para el manejo
 Manual de instruções
 Naudojimosi instrukcija
 Kasutusjuhend
 Lietošanas instrukcija
 Οδηγίες χρήσης
 取扱説明書
 사용설명서

Driftsinstruks
 Driftsinstruktioner
 Käyttöohje
 Driftsvejledning
 Instrukcja obsługi
 Kezelési útmutató
 Návod k obsluze
 Navodilo za uporabo
 Návod na obsluhu
 El Kitabi
 Инструкция по эксплуатации
 使用说明书

SV 5.1050

2006/42/EG



DIN EN ISO 14001:2005

DIN EN ISO 9001
001929 QM

	<p>MAX. PRESSURE</p> <p>MAX. VACUUM</p>		mbar
		<p>MAX.</p>	
<p>AIR</p>		<p>DIN EN ISO 3744</p> <p>STANDARD</p>	<p>$L_{pA} = 76 \text{ dB(A)} - 50\text{Hz}$</p> <p>$L_{pA} = 80 \text{ dB(A)} - 60\text{Hz}$</p> <p>$K_{pA} = 3 \text{ dB(A)}$</p>

	<p>$A > 100\text{mm}$</p> <p>$A > 4"$</p>	<p>$> -20^\circ\text{C}/-4^\circ\text{F}$</p> <p>$< 40^\circ\text{C}/104^\circ\text{F}$</p>	<p>max. 90%</p>	<p>max. 800m</p>
<p>1</p> <p>173 kg 381 lbs</p>	<p>2</p>			

28100016900 10/11

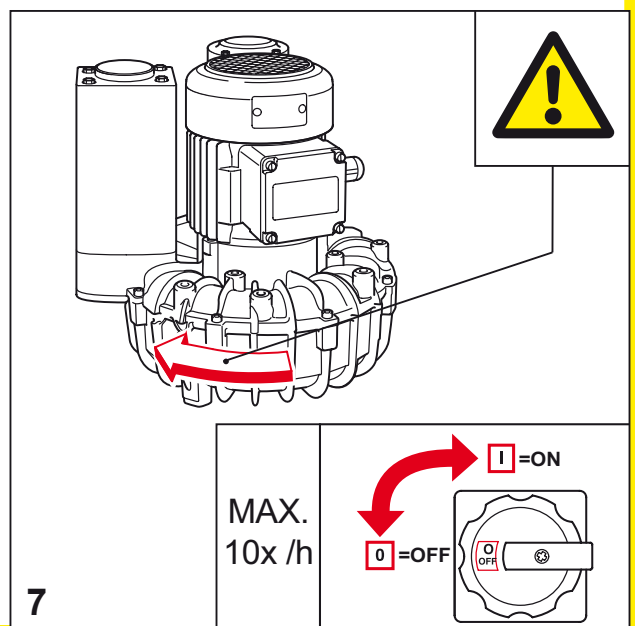
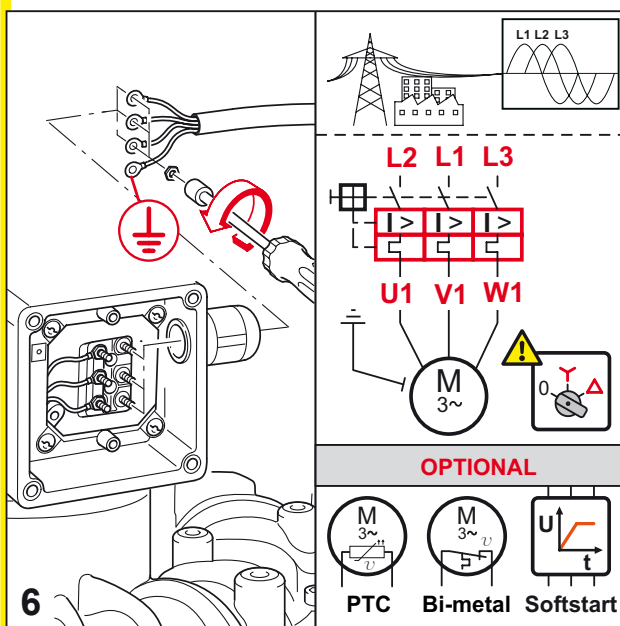
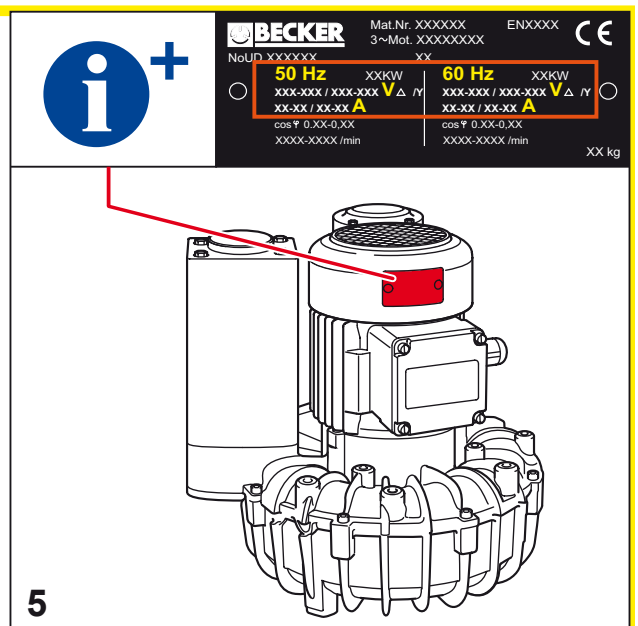
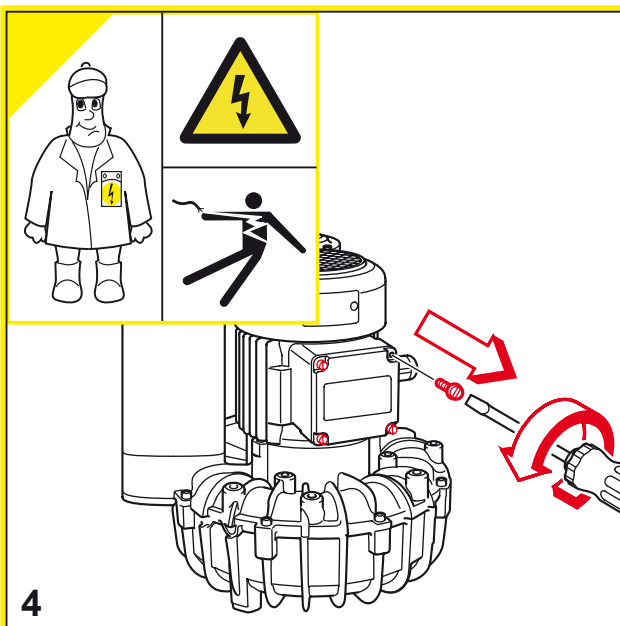
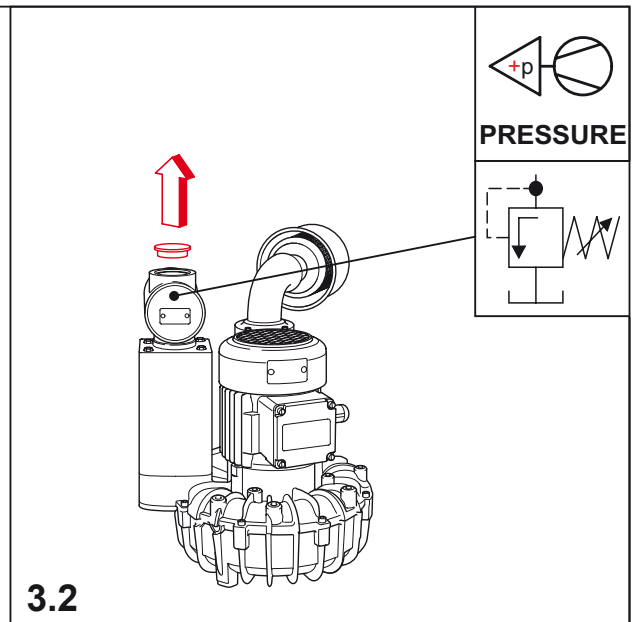
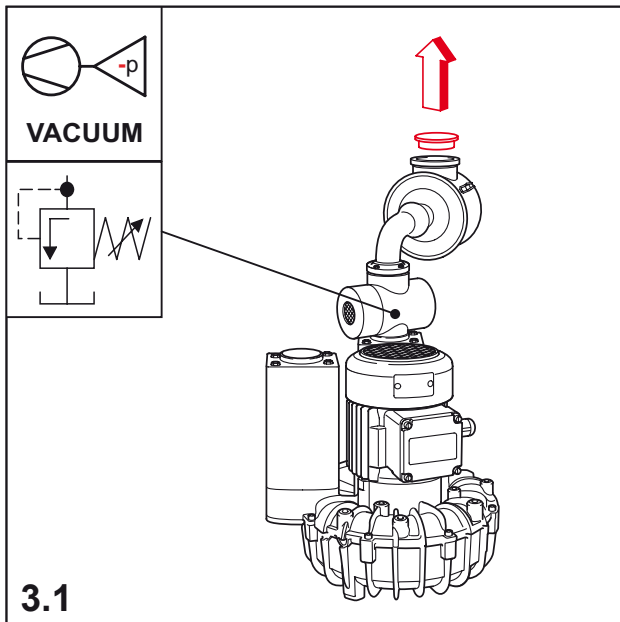

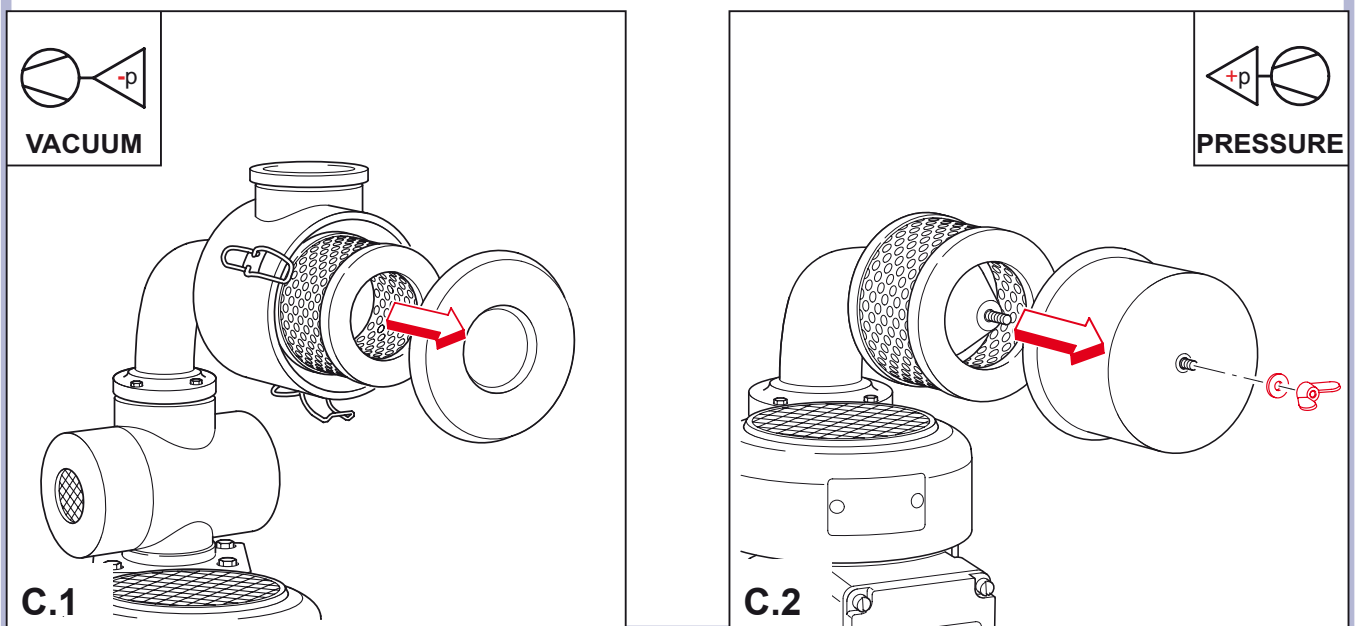
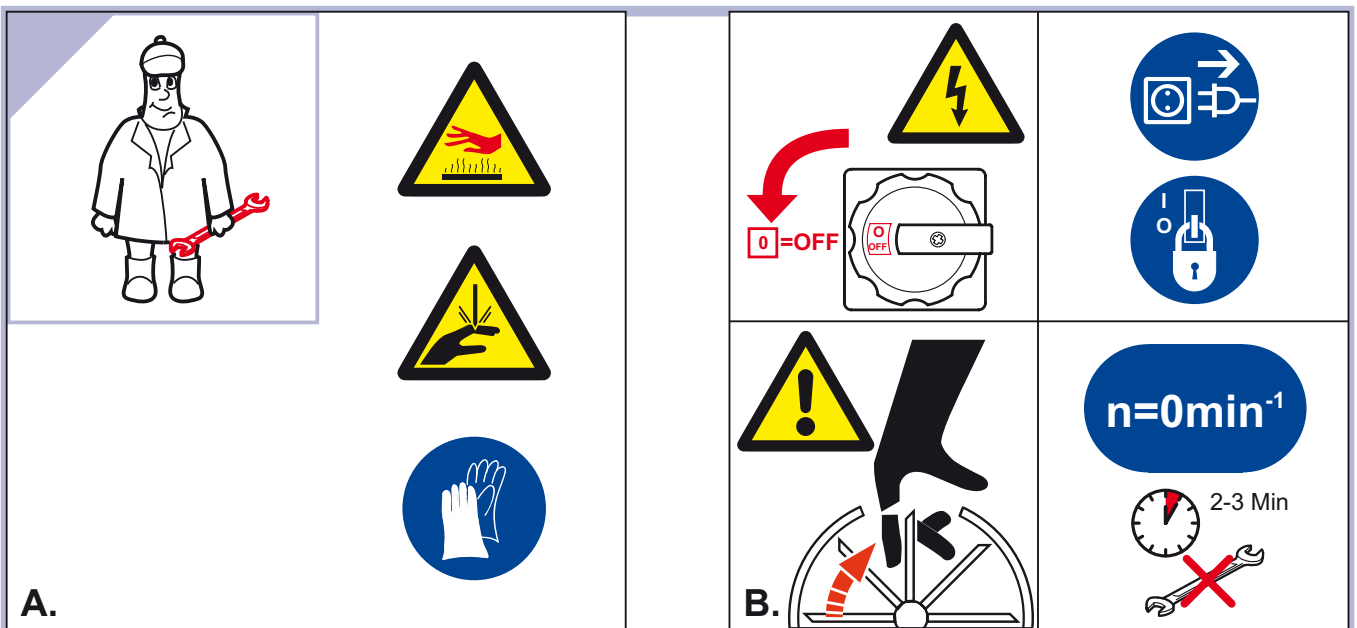
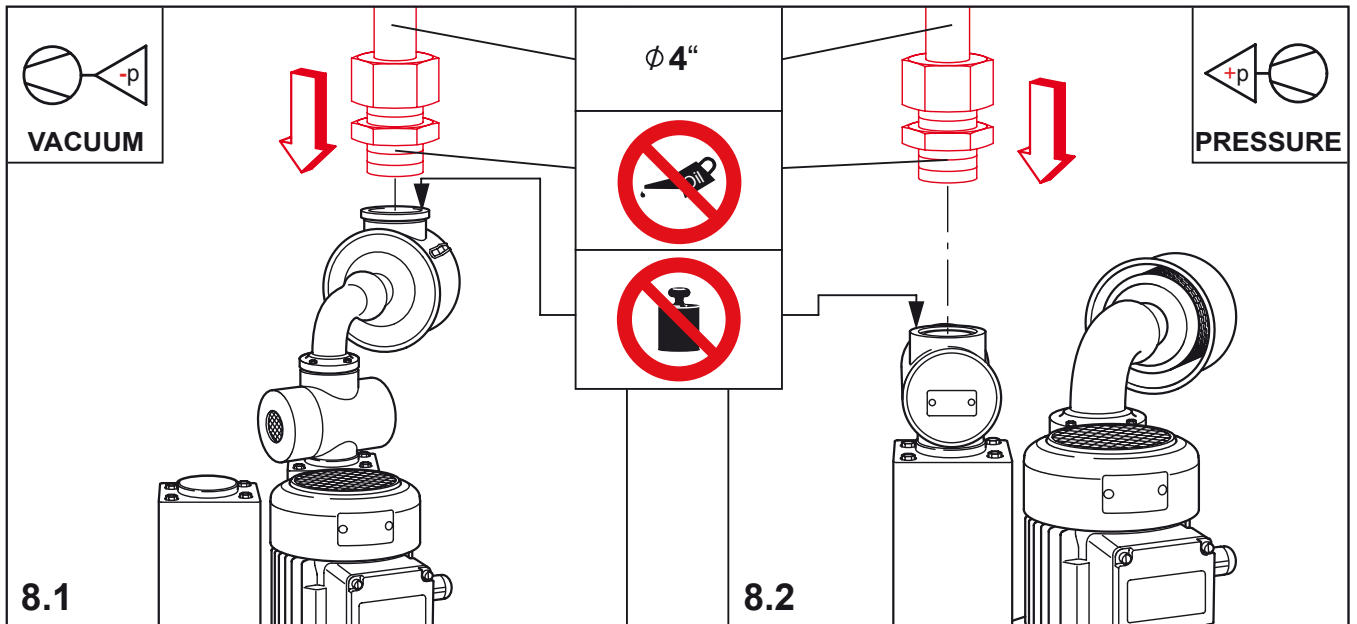

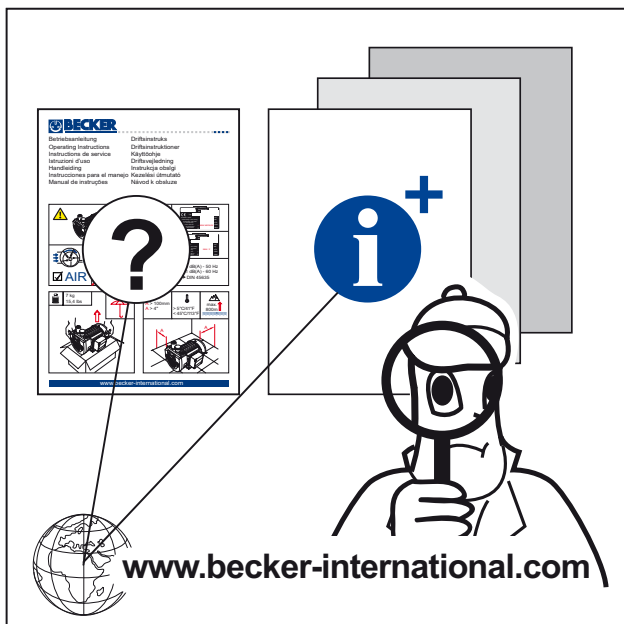
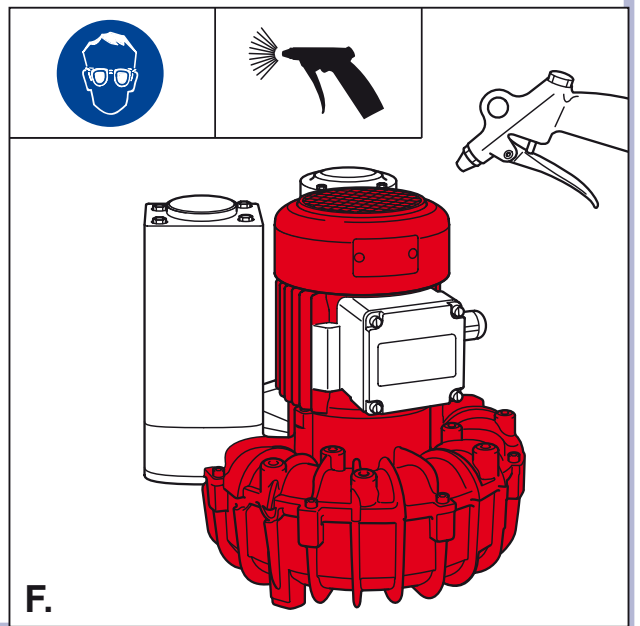
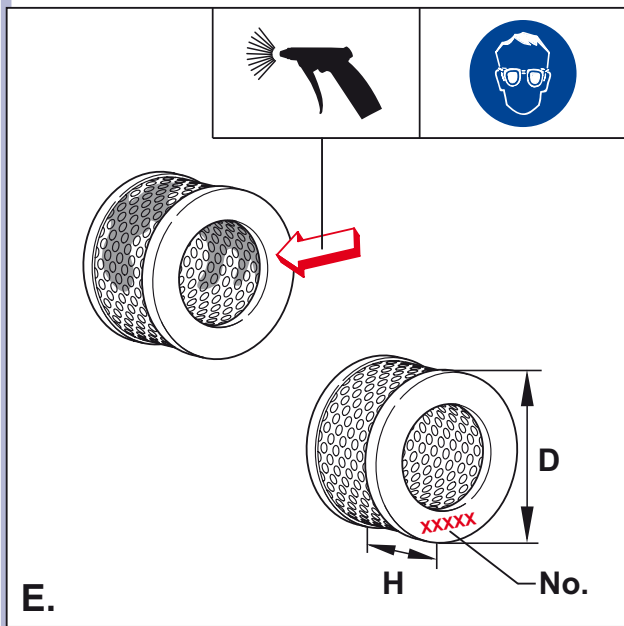
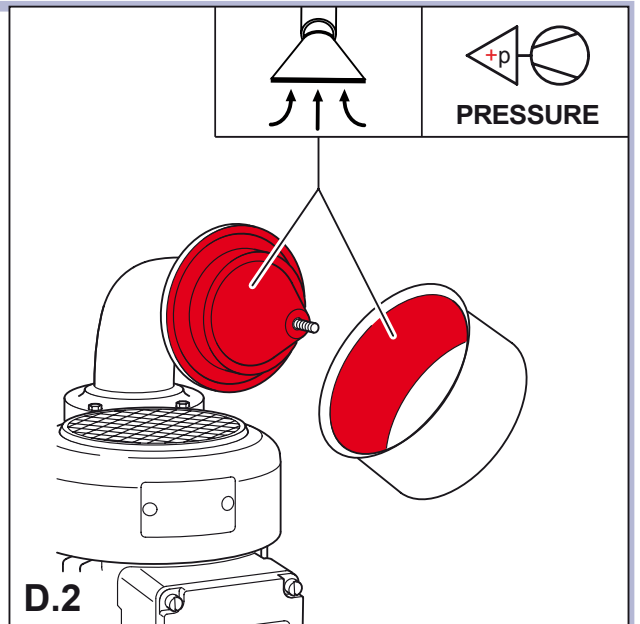
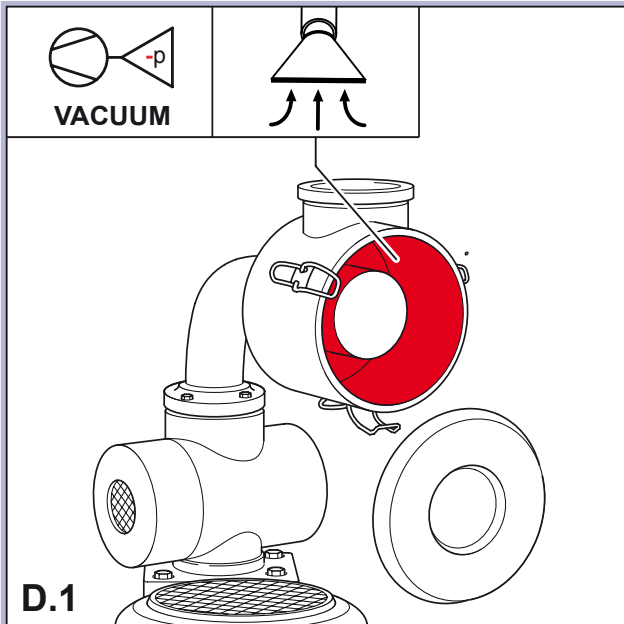

BECKER

Gebr. Becker GmbH
 Hölker Feld 29-31
 D-42279 Wuppertal
 info@becker-international.com

SERVICE
www.becker-international.com
 Sales and service network